

SOLAHART SUNCELL-PLUS COMMERCIAL SOLAR PANEL

SOLAHART445C1

The new high-performance Solahart SunCell-Plus panel is not only great value, but is also custom designed and built to Solahart's strict specifications.

With a high efficiency of 20.5%, proven durability and easy-to-handle design, Solahart SunCell-Plus is the ideal solution for commercial installations.

Reliable silicone connections also ensure excellent stability and durability. Other features include genuine Stäubli MC4 EVO2 connectors to secure a reliable connection and a sealed junction box that offers corrosion protection and water resistance.

The 12-Year Solahart Product Warranty provides ultimate confidence and peace of mind.

State-of-the-art half-cell technology:

For excellent performance under real conditions.

High efficiency:

Optimal yields, more power generated per square metre.

Low electricity generation costs:

High energy produced per panel means you pay less for electricity generated.

Efficient, and durable:

Manufactured to specification and only available through Solahart.



HOW YOU BENEFIT



HIGH SOLAR YIELD

Innovative half-cell technology with excellent power efficiency that results in more energy production per square metre.



SAFE OPERATION

Quality components ensure safety and long term performance.



VALUE FOR MONEY

Cost-effective panel solution for a high return on your investment.



TRUSTED WARRANTIES

12-Year Solahart Product Warranty for peace of mind, plus, 25-Year Manufacturer's Performance Guarantee.*

Technical Data

MODEL

SOLAHART445C1

Electrical Data

Minimum performance at standard test conditions, STC⁽¹⁾ (Power Tolerance +5 W / -0 W)

Power at MPP ⁽²⁾ - P _{MPP}	445 Wp
Short circuit current - I _{sc}	11.30 A
Open circuit voltage - V _{oc}	48.80 V
Current at MPP - I _{MPP}	10.84 A
Voltage at MPP - V _{MPP}	41.05 V
Efficiency ⁽¹⁾ - η	20.5%

Minimum performance at normal operating conditions, NMOT⁽³⁾

Power at MPP - P _{MPP}	330.8 Wp
Short circuit current - I _{sc}	9.10 A
Open circuit voltage - V _{oc}	45.70 V
Current at MPP - I _{MPP}	8.68 A
Voltage at MPP - V _{MPP}	38.12 V

⁽¹⁾1000 W/m², 25±2°C, AM 1.5 G. ⁽²⁾Measurement tolerances P_{MPP} ±3%; I_{sc}, V_{oc} ±5% at STC. ⁽³⁾800 W/m², NMOT, spectrum AM 1.5 G. * Typical values, actual values may differ.

Other Information

Part Number	SOLAHART445C1
Solahart Product Warranty*	12 years
Manufacturer's Performance Guarantee*	25 years
Country of Manufacture	China

Mechanical Data

Dimensions (H x W x D)	2094 x 1038 x 35 mm (including frame)
Weight	23.5 Kg
Glass thickness	3.2 mm
Backsheet	White
Frame	Silver Anodised Aluminium
Cell	6 x 24 monocrystalline solar half-cells
Number of diodes	3
Junction box	Protection class IP68, with bypass diodes
Cable	4 mm ² solar cable; (+) 1300 mm, (-) 1300 mm
Connector	Stäubli MC4 EVO2 connectors (PV-KST4 EVO 2 & PV-KBT4 EVO 2)

Manufacturer's Performance Guarantee

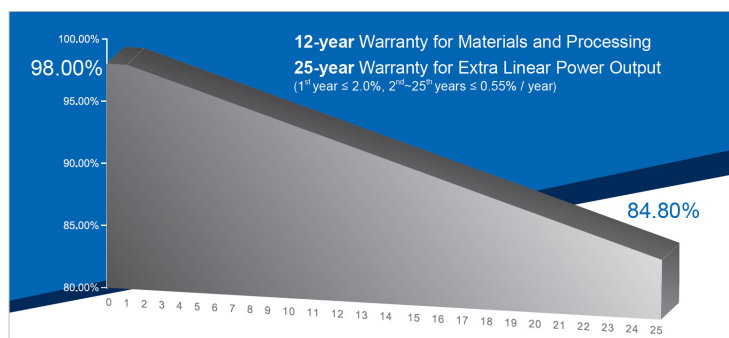

At least 98% of nominal power during the first year.

Thereafter max 0.6% degradation per year.

At least 84.8% of nominal power up to 25 years.

All data within measurement tolerances.

Temperature Coefficients

Normal module operating temperature (NMOT)	41±2°C
Temperature coefficient of P _{MPP} - γ	-0.35%/°C
Temperature coefficient of V _{oc} - β	-0.28%/°C
Temperature coefficient of I _{sc} - α	+0.035%/°C

Properties for System Design

Maximum system voltage - V _{sys}	1500 V
Maximum reverse current - I _r	20 A
Maximum design load, Push / Pull	3600 / 1600 Pa
Maximum test load, Push / Pull	5400 / 2400 Pa
Fire rating based on IEC / UL	Class C / TYPE 4

Qualifications and Certificates

IEC 61215: 2016; IEC 61730: 2016, Application class II.

Dimensions - Measurements in mm

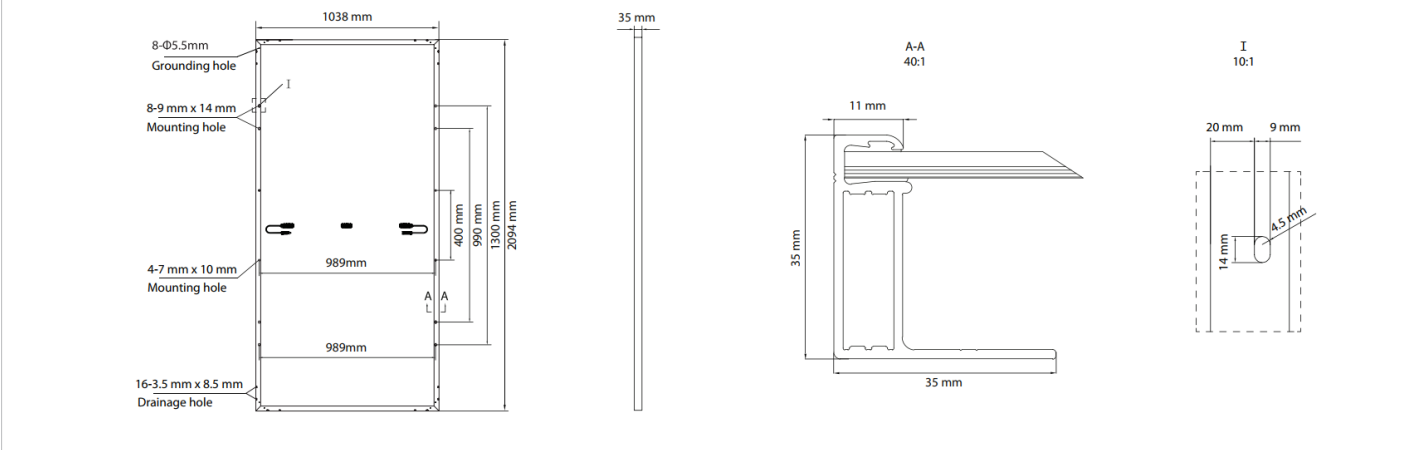

Licence Holder and Importer:

Solahart Industries Pty Ltd., 1 Alan St. Rydalmere, NSW 2116, Australia.

*For full details see Solahart Owner's Guide & Installation Instructions.

Specifications and designs included in this data sheet are subject to change without notice.

Solahart Australia 1300 769 475 | www.solahart.com.au

Reorder code: SHDS/PV_SH445_SUNCP IH0113_Solahart SunCell Plus Solar Panel_445W_June 2021