



Continuous Flow Gas Booster Solar Water Heater



Owner's Guide and Installation Instructions



WARNING: Plumber – Be Aware

Use copper pipe **ONLY**. Plastic pipe **MUST NOT** be used.

It is a requirement of a solar water heater installation that all pipe work be in copper and not plastic, due to the effects of high water temperatures and pressures.

This water heater must be installed and serviced by a qualified person.
Please leave this guide with the householder.

 **Warning:** Upon completion of the installation and commissioning of the water heater, leave this guide with the householder or a responsible officer. **DO NOT** leave this guide inside of the cover of the water heater, as it may interfere with the safe operation of the water heater or ignite when the water heater is turned on.

An electronic copy of these Owner's Guide and Installation Instructions can be downloaded from solahart.com.au.

Solahart Industries Pty Ltd is the supplier of the Solahart range of continuous flow gas water heaters, manufactured in Japan by Paloma Co., Ltd., a world leader in water heater technology and manufacture.

PATENTS

This water heater may be protected by one or more patents or registered designs in the name of Solahart Industries Pty Ltd, Rheem Australia Pty Ltd or Paloma Co., Ltd.

TRADE MARKS

® Registered trademark of Solahart Industries Pty Ltd or Rheem Australia Pty Ltd.
™ Trademark of Solahart Industries Pty Ltd or Rheem Australia Pty Ltd.

Note: Every care has been taken to ensure accuracy in preparation of this publication. No liability can be accepted for any consequences, which may arise as a result of its application.

CONTENTS

HOUSEHOLDER

This booklet contains important information about your new water heater, including terms of the Solahart warranty.

We recommend you read pages 7 to 17, and the terms of the Solahart warranty on pages 4 to 6.

The other pages are intended for the installer but may be of interest.

Warranty	4
Safety, Warnings, Installation Notes	7
About Your Water Heater	9
Water Supplies.....	14
Save A Service Call	15
Installation – Water Heater	18
Connections – Plumbing	26
Connections – Electrical.....	27
Multiple Installations.....	29
Commissioning.....	33
Draining The Water Heater	39
Solahart Offices	40

SOLAHART CONTINUOUS FLOW GAS BOOSTER WATER HEATER WARRANTY – AUSTRALIA ONLY

CONTINUOUS FLOW GAS BOOSTER 26 MODELS

1. THE SOLAHART WARRANTY – GENERAL

- 1.1 This warranty is given by Solahart Industries Pty Limited ABN 45 064 945 848 of 1 Alan Street, Rydalmere New South Wales, the supplier of Solahart continuous flow gas water heaters, manufactured by Paloma Co., Ltd., a world leader in water heater technology and manufacture.
- 1.2 Solahart offers national service through its Dealer network. Solahart will repair or replace components at the address of the water heater subject to the terms of the Solahart warranty. Solahart, in addition can provide preventative maintenance and advice on the operation of your water heater.
- 1.3 For details about this warranty, you can contact us on 1800 638 011.
- 1.4 The terms of this warranty and what is covered by it are set out in sections 2 and 3 and apply to water heaters manufactured after 1st November 2018.
- 1.5 If a subsequent version of this warranty is published, the terms of that warranty and what is covered by it will apply to water heaters manufactured after the date specified in the subsequent version.

2. TERMS OF THE SOLAHART WARRANTY AND EXCLUSIONS TO IT

- 2.1 The decision of whether to repair or replace a faulty component is at Solahart's sole discretion.
 - 2.2 If you require a call out and we find that the fault is not covered by the Solahart warranty, you are responsible for our standard call out charge. If you wish to have the relevant component repaired or replaced by Solahart, that service will be at your cost.
 - 2.3 Where a failed component or cylinder is replaced under this warranty, the balance of the original warranty period will remain effective. The replacement does not carry a new Solahart warranty.
 - 2.4 Where the water heater is installed outside the boundaries of a metropolitan area as defined by Solahart or further than 30 km from a regional Solahart Dealer, the cost of transport, insurance and travelling between the nearest Solahart Dealer's premises and the installed site shall be the owner's responsibility.
 - 2.5 Where the water heater is installed in a position that does not allow safe or ready access, the cost of that access, including the cost of additional materials handling and/or safety equipment, shall be the owner's responsibility. In other words, the cost of dismantling or removing cupboards, doors or walls and the cost of any special equipment to bring the water heater to floor or ground level or to a serviceable position is not covered by this warranty.
 - 2.6 This warranty only applies to the original and genuine Solahart water heater in its original installed location and any genuine Solahart replacement parts.
 - 2.7 The Solahart warranty does not cover faults that are a result of:
 - a) Accidental damage to the water heater or any component (for example: (i) Acts of God such as floods, storms, fires, lightning strikes and the like; and (ii) third party acts or omissions).
 - b) Misuse or abnormal use of the water heater.
 - c) Installation not in accordance with the Owner's Guide and Installation Instructions or with relevant statutory and local requirements in the State or Territory in which the water heater is installed.
 - d) Connection at any time to a water supply that does not comply with the water supply guidelines as outlined in the Owner's Guide and Installation Instructions.
 - e) Repairs, attempts to repair or modifications to the water heater by a person other than the Solahart Dealer or a Solahart Accredited Service Agent.
-

SOLAHART CONTINUOUS FLOW GAS BOOSTER WATER HEATER WARRANTY – AUSTRALIA ONLY

CONTINUOUS FLOW GAS BOOSTER 26 MODELS

- f) Faulty plumbing or faulty gas or power supply.
 - g) Failure to maintain the water heater in accordance with the Owner's Guide and Installation Instructions.
 - h) Transport damage.
 - i) Fair wear and tear from adverse conditions (for example, corrosion).
 - j) Cosmetic defects.
 - k) Ice formation in the waterways of a water heater: where the electricity supply has been switched off or has failed and the water heater has not been drained in accordance with the instructions; or due to an ambient temperature below -20°C (including wind chill factor).
- 2.8 Subject to any statutory provisions to the contrary, this warranty excludes any and all claims for damage to furniture, carpet, walls, foundations or any other consequential loss either directly or indirectly due to leakage from the water heater, or due to leakage from fittings and/ or pipe work of metal, plastic or other materials caused by water temperature, workmanship or other modes of failure.

3. WHAT IS COVERED BY THE SOLAHART WARRANTY FOR THE WATER HEATERS DETAILED IN THIS DOCUMENT

- 3.1 Solahart will repair or replace a faulty component of your water heater if it fails to operate in accordance with its specifications as follows:

What components are covered	The period from the date of installation in which the fault must appear in order to be covered	What coverage you receive
All components (all installations)	Year 1	Repair and/or replacement of the faulty component, free of charge, including labour.
All components (only if the water heater is installed in a single-family domestic dwelling)	Years 2 & 3	Repair and/or replacement of the faulty component, free of charge, including labour.
The heat exchanger (only if the water heater is installed in a single-family domestic dwelling)	Years 4 & 5	Replacement heat exchanger, free of charge. Installation and repair labour costs are the responsibility of the owner.

SOLAHART CONTINUOUS FLOW GAS BOOSTER WATER HEATER WARRANTY – AUSTRALIA ONLY

CONTINUOUS FLOW GAS BOOSTER 26 MODELS

4. ENTITLEMENT TO MAKE A CLAIM UNDER THIS WARRANTY

- 4.1 To be entitled to make a claim under this warranty you need to:
- a) Be the owner of the water heater or have consent of the owner to act on their behalf.
 - b) Contact Solahart without undue delay after detection of the defect and, in any event, within the applicable warranty period.
- 4.2 You are **not** entitled to make a claim under this warranty if your water heater:
- a) Does not have its original serial numbers or rating labels.
 - b) Is not installed in Australia.

5. HOW TO MAKE A CLAIM UNDER THIS WARRANTY

- 5.1 If you wish to make a claim under this warranty, you need to:
- a) Contact Solahart on 1800 638 011 and provide owner's details, address of the water heater, a contact number and date of installation of the water heater or if that's unavailable, the date of manufacture and serial number (from the rating label on the water heater).
 - b) Solahart will arrange for the water heater to be tested and assessed on-site.
 - c) If Solahart determines that you have a valid warranty claim, Solahart will repair or replace the water heater in accordance with this warranty.
- 5.2 Any expenses incurred in the making of a claim under this warranty will be borne by you.

6. THE AUSTRALIAN CONSUMER LAW

- 6.1 Our goods come with guarantees that cannot be excluded under the Australian Consumer Law. You are entitled to a replacement or refund for a major failure and for compensation for any other reasonably foreseeable loss or damage. You are also entitled to have the goods repaired or replaced if the goods fail to be of acceptable quality and the failure does not amount to a major failure.
- 6.2 The Solahart warranty (set out above) is in addition to any rights and remedies that you may have under the Australian Consumer Law.

SAFETY, WARNINGS, INSTALLATION NOTES

It is important you read the following safety and warnings information.

SAFETY AND WARNINGS

- This water heater is only intended to be operated by persons who have the experience or the knowledge and the capabilities to do so.
- This water heater is not intended to be operated by persons with reduced physical, sensory or mental capabilities i.e. the infirm, or by children. Children should be supervised to ensure they do not interfere with the water heater.
- If the power supply cord or plug is damaged, it must be replaced by a qualified person in order to avoid a hazard. The power supply cord and plug must be replaced with a genuine replacement part available from Solahart. Phone your nearest Solahart Dealer to arrange for an inspection.
- The power lead from the water heater must be plugged into a weatherproof electrical outlet. Take care not to touch the power plug with wet hands.
- The water heater uses 220 V - 240 V a.c. electrical power for operation of the control systems and the combustion fan. The removal of the front panel will expose 220 V - 240 V a.c. wiring. It must only be removed by a qualified person.
- This water heater is supplied with temperature sensors, a FlameSafe® protection system and a pressure relief valve. These devices must not be tampered with or removed. The water heater must not be operated unless each of these devices is fitted and is in working order.

The Solahart warranty may not cover faults if safety devices or the relief valve are tampered with or if the installation is not in accordance with these instructions.

- Temperature controllers **must not** be fitted to this water heater as part of a solar water heater system because water at a temperature much higher than the controller setting can be delivered.
- For continued safety of this water heater it must be installed, operated and maintained in accordance with the Owner's Guide and Installation Instructions.
- Servicing of the water heater must only be carried out by qualified personnel. Phone your nearest Solahart Dealer.
- Do not modify this water heater.
- Switch off the electrical supply at the power outlet to the water heater prior to performing general maintenance. This will prevent the water heater from operating while you clean or spray around the water heater. Refer to "[General Maintenance](#)" on page 11 for additional information.
- Do not spray **aerosols** in the vicinity of this water heater while it is in operation. Propellants and gases in many aerosol sprays contain hydrocarbons which are flammable. Gases from aerosol sprays may also become corrosive when drawn into a flame.
- Do not use or store **flammable materials** in or near this water heater. Flammable liquids (such as petrol), combustible materials (such as newspapers) and similar articles must be kept well away from the water heater and the flue terminal.
- Do not store **swimming pool chemicals, household cleaners, etc.**, near the water heater.
- Do not place articles on or against this water heater, or in contact with the flue terminal. Ensure the flue terminal is not obstructed in any way at any time.
- Do not use Propane / Butane gas mixtures in a Propane model. A Propane model is designed to operate on Propane only. The use of Propane / Butane mixture, such as automotive LP gas fuel, in a Propane model is unsafe and can cause damage to the water heater.



- The water heater has a frost protection system to protect against damage by preventing ice forming in the waterways of the water heater, in the event of freezing conditions occurring. The frost protection system will be rendered inoperable if electrical power is not available at the water heater. If it is necessary to switch the power off to the water heater and there is a risk of freezing, then it is necessary to drain the water heater. Refer [“Frost Protection”](#) on page 10 and to [“Draining the Water Heater”](#) on page 12.

INSTALLATION NOTES

This water heater must be installed:

- by a qualified person,
- in accordance with the installation instructions,
- in compliance with the Plumbing Code of Australia (PCA) and Plumbing Standard AS/NZS 3500.4,
 - This water heater is designed for outdoor installation only.
 - This water heater is intended to be permanently connected to the water mains and not connected by a hose-set. A braided flexible hose or semi-flexible connector may be used for connection to the water heater, where permitted by AS/NZS 3500.4.
- in compliance with the Gas Installations Standard AS/NZS 5601.1,
 - The Gas installations Standard AS/NZS 5601.1 places limitations on the location of a gas water heater within a covered area. Refer to [“Installation within a Covered Area”](#) on page 20.
- in compliance with all local codes and regulatory authority requirements.

Installation and commissioning requirements and details for the installing plumber and licensed electrical worker are contained on [pages 18 to 38](#).

Mains pressure water supply

The water heater is designed to operate at mains pressure by connecting directly to the mains water supply. The maximum mains water supply pressure for the water heater is 1,000 kPa.

Where the mains water supply pressure exceeds 1,000 kPa:

- an approved pressure limiting valve is required and should be fitted prior to the solar storage tank. The solar storage tank may have a lower mains supply pressure requirement, which would govern the maximum supply pressure to the system, or
- if the water heater is installed as a stand-alone water heater and not as an in-series gas booster to a solar water heater, an approved pressure limiting valve that does not have non-return valve characteristics (such as an RMC PSL series valve) must be installed.

A minimum water supply pressure of 120 kPa is required to achieve the rated flow and performance of the water heater.

Refer to [“Mains Water Supply”](#) on page 21 for additional information.

Mounting of the water heater

This water heater must be installed vertically upright with the water, gas and power connections on the underside, pointing toward the ground. The back of the water heater can be either against a wall or supported by a frame. The water heater must be well secured to the wall or frame using two fasteners, suitable for the wall or frame type, each at the top and bottom of the unit. Refer to the [note](#) on page 19 for additional information.

Alternatively the water heater can be installed recessed into a wall, using a proprietary made recess box from Solahart for such an installation. Refer to the installation instructions which accompany the recess box kit for the dimensions of the space required and information on its installation. Refer also to [“Recess Installation”](#) on page 20.

ABOUT YOUR WATER HEATER

WATER HEATER APPLICATION

This water heater is designed for use in a single family domestic dwelling for the purpose of heating potable water. Its use in an application other than this may shorten its life.

MODEL TYPE

The Solahart® continuous flow water heater model you have chosen is for outdoor installation only. This water heater has been installed as an in-series gas booster to a solar water heater.

GAS BOOSTING FOR A SOLAR WATER HEATER

Water stored in the solar storage tank passes through the in-series gas booster when a hot tap is opened. The in-series gas booster is for heating water at times of low solar energy gain, such as during cloudy or rainy weather, or during colder months.

Solar heated water can reach temperatures up to 70°C to 80°C for a Streamline pumped system or up to 85°C for a Thermosiphon system with an over temperature protection system and possibly higher for a Thermosiphon system without an over temperature protection system. When the solar heated water temperature is 58°C or higher, the flow passes through the in-series gas booster without boosting.

The in-series gas booster operates automatically if heating of the water is required. When a hot tap is opened and the solar heated water temperature is below 58°C, the gas burners ignite to provide immediate heating of the water to its preset outlet temperature setting as the water passes through the water heater. The heat produced by the burner is transferred to the water through the heat exchanger. The water is heated to a constant temperature by the automatic adjustment of the gas supply to the burner to suit the water flow rate. The gas burners extinguish when the hot tap is closed.

Automatic safety controls are fitted to the water heater to provide safe and efficient operation.

For information relating to the function and operation of the solar water heater, refer to the Owner's Guide and Installation Instructions supplied with the solar water heater.

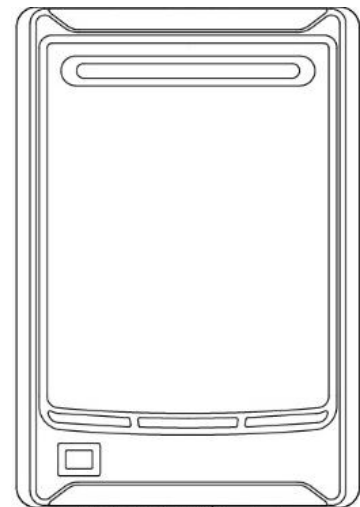

HOW HOT SHOULD THE WATER BE?

The solar water heater will deliver water at temperatures up to 70°C to 80°C for a Streamline pumped system or up to 85°C for a Thermosiphon system with an over temperature protection system and possibly higher for a Thermosiphon system without an over temperature protection system. During periods of low solar energy gain, the in-series gas booster will boost the water temperature automatically to its preset outlet temperature setting. The factory preset outlet temperature setting is 60°C.

Note: The preset outlet temperature setting of this water heater cannot be adjusted by the householder. The setting can only be adjusted by the installer or a Solahart Dealer.

Note: AS 3498 requires that a water heater provides the means to inhibit the growth of Legionella bacteria in potable water. When this water heater is used as an in-series booster for a solar water heater it can satisfy this AS 3498 requirement provided it is energised, the booster preset outlet temperature setting is 70°C or higher, and that a remote temperature controller is not used.

⚠ Warning: Temperature controllers **must not** be fitted to this water heater as part of a solar water heater system because water at a temperature much higher than the controller setting can be delivered.

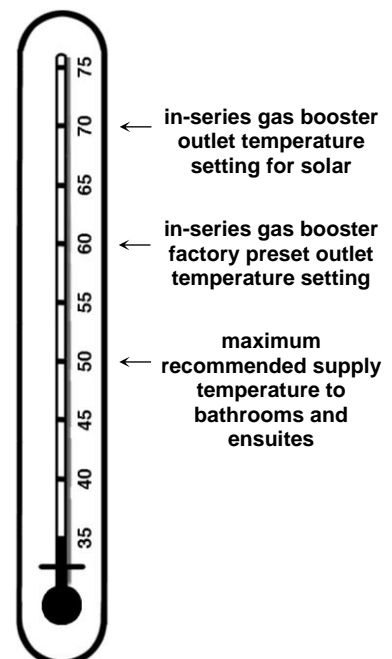

HOTTER WATER INCREASES THE RISK OF SCALD INJURY

This water heater used as a booster to a solar water heater can deliver hot water at a temperature up to and at times exceeding 70°C, sufficiently hot to cause severe scalding. Water at this temperature may have been plumbed to fixtures where water hotter than 50°C is allowed, such as the kitchen and laundry.

Check the water temperature before use, such as when entering a shower or filling a bath or basin, to ensure it is suitable for the application and will not cause scald injury.

We recommend and it may be required by regulations that an approved temperature limiting device be fitted into the hot water piping to the bathroom and ensuite when this water heater is installed. This will keep the water temperature below 50°C at the bathroom and ensuite. The risk of scald injury will be reduced and still allow hotter water to the kitchen and laundry.

REDUCED HOT WATER FLOW WHEN HEAT EXCHANGER IS COLD

At a cold start-up, i.e. when the water heater has not operated for some time (which is most often first thing in the morning), the initial flow of hot water may be reduced for a period of 5-10 seconds while the heat exchanger warms up. **This is both an energy and water saving feature of this water heater.** Once the heat exchanger has warmed up the hot water flow will increase and remain at normal flow levels. This feature will only occur at a cold start-up and not when the heat exchanger is already warm from a recent use of hot water.

FROST PROTECTION

The in-series gas booster has a frost protection system. The frost protection system will protect the in-series gas booster from damage, by preventing ice forming in the waterways of the in-series gas booster, in the event of freezing conditions occurring.

Notes

- The frost protection system will be rendered inoperable if electrical power is not available at the water heater. Damage caused by freezing due to the unavailability of power at the water heater is not covered by the Solahart warranty (refer to [“Terms of the Solahart Warranty”](#) on page 4).
- If it is necessary to switch the power off to the water heater and there is a risk of freezing, then it is necessary to drain the water heater (refer to [“Draining the Water Heater”](#) on page 12).
- Pipe work to and from the water heater must be adequately insulated to prevent freezing.
- The water heater is not suitable for installation in areas where the ambient temperature falls below -20°C (including wind chill factor).
- Refer to [“Terms of the Solahart Warranty”](#) on page 4.

PRECAUTIONS

The water heater must be maintained in accordance with the Owner’s Guide and Installation Instructions. Refer to [“General Maintenance”](#) on page 11 and [“Major Service Every Five Years”](#) on page 11.

If this water heater is to be used where an uninterrupted hot water supply is necessary for your application or business you should ensure that you have back-up redundancy within the hot water system design. This should ensure the continuity of hot water supply in the event that this water heater were to become inoperable for any reason. We recommend you seek advice from a plumber or specifier about your needs and building back-up redundancy into your hot water supply system.

GENERAL MAINTENANCE

General maintenance can be performed by the dwelling occupant. It is recommended general maintenance be conducted every six months or more regularly as required.

Switch off the electrical supply at the power outlet to the water heater prior to performing general maintenance. This will prevent the water heater from operating while you clean or spray around the water heater. Switch on the electrical supply at the power outlet to the water heater when finished performing the general maintenance.

The general maintenance includes:

- The jacket of the water heater can be cleaned with a soft cloth and warm mild soapy water if required. Under no circumstances should abrasive materials or powders be used.
- Inspect around the air inlet, flue terminal and the water heater in general for plant growth.
 - Trim back any shrubs, bushes or other plants which have encroached around the water heater.

Plant growth across the air inlet and flue terminal can interfere with the performance of the water heater.

- Inspect around the water heater for infestations of insects, such as ants. Insects encroaching into or nesting in the water heater can interfere with the operation of the water heater and also damage components. The area around the water heater can be sprayed with insecticide to rid the area of insects.

⚠ Warning: Do not spray insecticide near the water heater while it is operating. Propellants in many insect sprays contain hydrocarbons which are flammable. Gases from aerosol sprays may also become corrosive when drawn into a flame.

- If necessary to rid the area of insects:
 - Ensure the electrical supply at the power outlet to the water heater has been switched off.
 - Spray the affected area, taking care not to spray into the air inlet or flue terminal or onto the surface of the water heater.
 - Wait a few minutes to allow any aerosol gases to dissipate before switching on the electrical supply at the power outlet to the water heater.

MAJOR SERVICE EVERY FIVE YEARS

For safe and efficient operation, it is recommended a major service be conducted on the water heater every five (5) years.

⚠ Warning: Servicing of a water heater must only be carried out by qualified personnel. Phone your nearest Solahart Dealer.

Note: The major service and routine replacement of any components, if required, are not included in the Solahart warranty. A charge will be made for this work. Only genuine replacement parts should be used on this water heater.

The major service includes the following actions:

- Check and if necessary adjust the gas pressure.
- Check the operation of and clean the burner.
- Check and clean the line strainer.
- Visually check the unit for any potential problems.
- Inspect all connections.

TO TURN OFF THE WATER HEATER

If it is necessary to turn off the water heater:

- Switch off the electrical supply at the power outlet to the water heater if there is no risk of freezing conditions occurring (refer to note below).
- Close the gas isolation valve at the inlet to the water heater.
- Close the solar heated water isolation valve at the inlet to the water heater.

Note: If there is a risk of freezing conditions, the electrical supply to the water heater should not be switched off unless the water heater is drained, otherwise damage could result (refer to [“Frost Protection”](#) on page 10 and [“Draining the Water Heater”](#) on page 12).

TO TURN ON THE WATER HEATER

- Screw in the drain plugs at the solar heated water inlet and hot water outlet of the water heater if the water heater has been drained.
- Open all of the hot taps in the house (don't forget the shower).
- Open the cold water isolation valve fully at the inlet to the solar water heater.
- Open the solar heated water isolation valve fully at the inlet to the in-series gas booster.
Air will be forced out of the taps.
- Close each tap as water flows freely from it.
- Open the gas isolation valve fully at the inlet to the water heater.
- Plug in the power supply cord at the power outlet.
- Switch on the electrical supply at the power outlet to the water heater.

The water heater will operate automatically when you open a hot tap if boosting is required.

DRAINING THE WATER HEATER

- Turn off the water heater (refer to [“Turn Off The Water Heater”](#) on page 12).
- Open a hot tap (preferably the shower outlet).
- Unscrew the two drain plugs, one each at the solar heated water inlet and hot water outlet, on the underside of the water heater.

Water will drain from the water heater.

- When water stops flowing from the water heater, close the hot tap.

Note: It is recommended not to screw the drain plugs back in, until the water heater is to be turned on again.

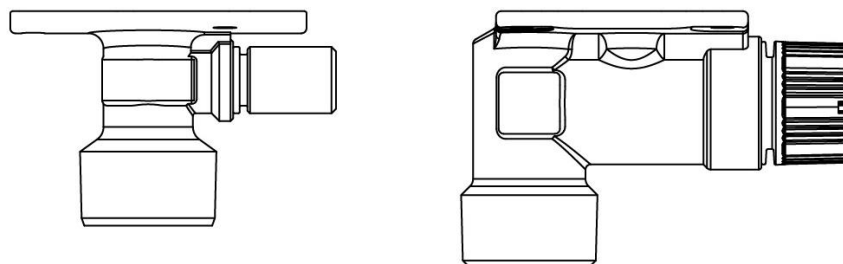

CIRCULATED HOT WATER FLOW AND RETURN SYSTEM

This model continuous flow water heater can be installed as part of a circulated hot water flow and return system in a building. Refer to [“Circulated Hot Water Flow and Return System”](#) on page 23 for further information and notes on this type of installation.

GOING ON HOLIDAYS

If you are going on holidays, it is not necessary to turn the water heater off. If it is necessary to turn off the water heater, refer to [“To Turn Off The Water Heater”](#) on page 12.

VICTORIAN CUSTOMERS

Notice to Victorian Customers from the Victorian Building Authority. This water heater must be installed by a licensed person as required by the Victorian Building Act 1993.

Only a licensed person will give you a Compliance Certificate, showing that the work complies with all the relevant Standards. Only a licensed person will have insurance protecting their workmanship for 6 years. Make sure you use a licensed person to install this water heater and ask for your Compliance Certificate.

DOES THE WATER CHEMISTRY AFFECT THE WATER HEATER?

The water heater is suitable for most public water supplies, however some water chemistries may have detrimental effects on the water heater, its components and fittings. Refer to [“Water Supplies”](#) on page 14.

If you are in a known harsh water area or you are not sure of your water chemistry, have your water checked against the conditions [described on page 14](#).

HOW LONG WILL THE WATER HEATER LAST?

The water heater is supported by a manufacturer’s warranty ([refer to page 4](#)). There are a number of factors that will affect the length of service the water heater will provide. These include but are not limited to the water chemistry, the water pressure, the water temperature (inlet and outlet) and the water usage pattern. Refer to [“Precautions”](#) on page 10.

WATER SUPPLIES

This water heater must be installed in accordance with this advice to be covered by the Solahart warranty.

This water heater is manufactured to suit the water conditions of most public reticulated water supplies. However, there are some known water chemistries which can have detrimental effects on the water heater and its operation and / or life expectancy. If you are unsure of your water chemistry, you may be able to obtain information from your local water supply authority. This water heater should only be connected to a water supply which complies with these guidelines for the Solahart warranty to apply.

CHANGE OF WATER SUPPLY

The changing or alternating from one water supply to another can have a detrimental effect on the operation and / or life expectation of a heat exchanger in a continuous flow water heater.

Where there is a changeover from one water supply to another, e.g. a rainwater tank supply, bore water supply, desalinated water supply, public reticulated water supply or water brought in from another supply, then water chemistry information should be sought from the supplier or it should be tested to ensure the water supply meets the requirements given in these guidelines for the Solahart warranty to apply.

SATURATION INDEX

The saturation index (SI) is used as a measure of the water's corrosive or scaling properties. The saturation index figures stated are calculated using a water temperature of 80°C.

In a corrosive water supply, the water can attack copper parts and cause them to fail. Where the saturation index is less than -1.0, the water is very corrosive and the Solahart warranty does not apply to a copper heat exchanger in a continuous flow water heater.

In a scaling water supply calcium carbonate is deposited out of the water onto any hot metallic surface. Where the saturation index exceeds +0.80, the Solahart warranty does not apply to a copper heat exchanger in a continuous flow water heater.

Water which is scaling may be treated with a water softening device to reduce the saturation index of the water.

Refer to the [Saturation Index chart](#) on page 14.

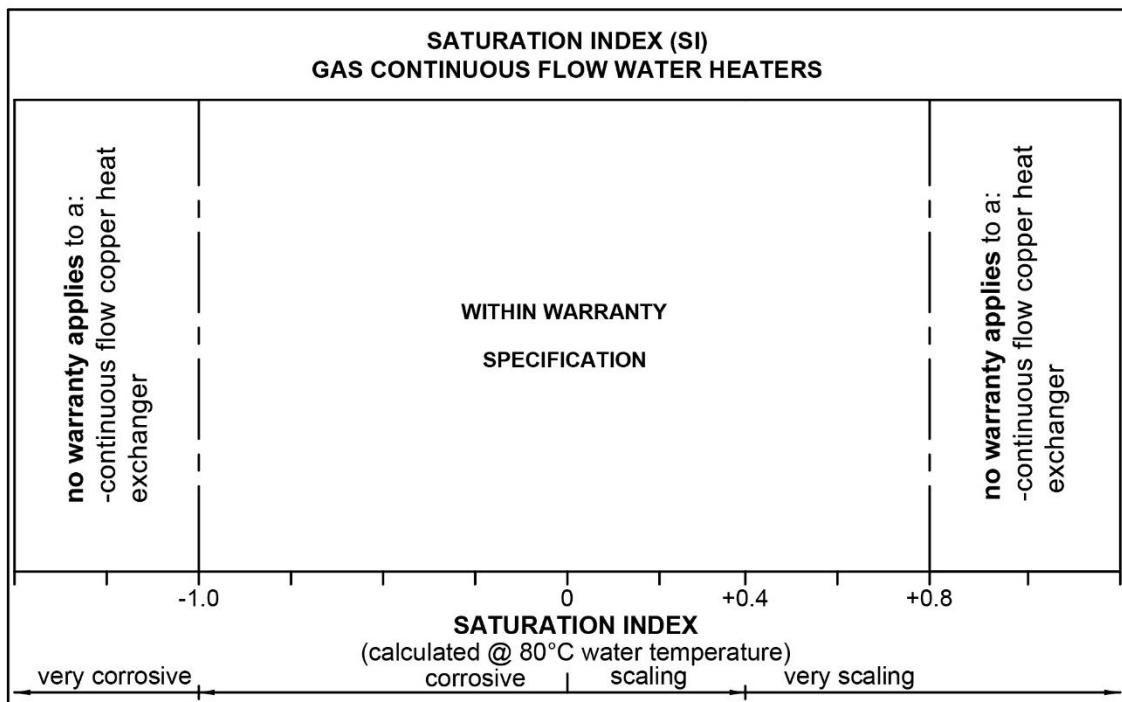

SAVE A SERVICE CALL

Check the items below before making a service call. You will be charged for attending to any condition or fault, which is not related to manufacture or failure of a part (refer to “[Terms of the Solahart Warranty](#)” on page 4).

COLD WATER FROM THE HOT TAP

- Close the hot tap, wait 10 seconds and open the hot tap again.
- Is the hot tap open enough?
The burners will not light if the flow rate is less than 2.0 L / min.
- Is the water heater plugged in and the power outlet switched on?
- Is power available in the house?
Try using another electrical appliance.
- Is the isolation valve in the gas line open?
- Is there a gas supply to the rest of the house?
Try lighting another gas appliance.
- Has the gas line been purged of air after installation?
Refer to the installing plumber.



REDUCED HOT WATER FLOW WHEN HEAT EXCHANGER IS COLD

At a cold start-up, i.e. when the water heater has not operated for some time (which is most often first thing in the morning), the initial flow of hot water may be reduced for a period of 5-10 seconds while the heat exchanger warms up. **This is both an energy and water saving feature of this water heater.** Once the heat exchanger has warmed up the hot water flow will increase and remain at normal flow levels. This feature will only occur at a cold start-up and not when the heat exchanger is already warm from a recent use of hot water.

NO WATER FROM THE HOT TAP

No flow of water from the hot tap may indicate a restriction in or failure of the cold water supply to the water heater. Check for water flow at other taps and that the cold water isolation valve ([refer to page 26](#)) is fully open.

WATER FLOW FLUCTUATES

Too many taps in use at the same time may cause a decrease in the hot water flow from the taps. This can also be evident if the water heater has been installed as an in-series gas booster to a solar water heater and the solar heated water is at a low temperature.

- Are there several hot taps open, or are appliances such as a dishwasher or washing machine, in use at the same time?
Ensure no more than two or three taps or appliances (26 litre models) are on at the one time.
- Check the flow of hot water from each tap to see if one or more outlets are using more water than you think.
Have a plumber install a flow control valve to each shower outlet, basin and sink to reduce water usage.

GAS BOOSTER OPERATING TOO FREQUENTLY

You may find that the in-series gas booster operates more frequently than expected. This will occur when the solar heated water temperature is lower than 58°C, which may be experienced during periods of low solar energy gain or if there has been heavy hot water usage. Factors to consider are:

- **Hot tap not used recently**

If a hot tap has not been used for a while, the water in the pipe work between the solar storage tank and the in-series gas booster may have cooled down. The in-series gas booster will sense the cooler water and this will cause the burners on the water heater to ignite and boost the water temperature when a hot tap is first turned on. The burners will extinguish when solar heated water of 58°C or higher from the solar storage tank reaches the in-series gas booster (refer also to [“Fan Continues to Run after Water Heater Operation Stops”](#) on page 16).

- **Insufficient sunlight**

Insufficient sunlight due to cloudy weather during hotter months or low solar energy contribution in colder months may mean the in-series gas booster operates more often.

- **Collectors shaded**

If trees or other objects shade the solar collectors or if the glass is dirty, the effectiveness of the solar collectors will be greatly reduced. Have the trees trimmed or the solar collectors relocated if the obstruction is permanent or clean the collector glass.

Ensure the glass on your solar collectors is free of dust, salt spray or any other matter, which may reduce the effectiveness of the solar collectors. If the collector glass becomes dirty, hose down or if the solar collectors are accessible, wash the collector glass with water and a soft brush when the solar collectors are cool.

- **Collector area is too small**

For most installations, the number of solar collectors recommended in Solahart literature has been proven to provide the required solar energy to meet the average family needs. However, in some circumstances, it may be necessary to install an additional solar collector.

- **Are you using more hot water than you think?**

Is one outlet (especially the shower) using more hot water than you think?

Very often it is not realised the amount of hot water used, particularly when showering. Carefully review the family's hot water usage. As you have installed an energy saving appliance, energy saving should also be practised in the home. Adjust your water usage pattern to take advantage of maximum solar gains.

Have a plumber install a flow control valve to each shower outlet, basin and sink to reduce water usage.

- **Water heater size**

Do you have the correct size water heater for your requirements?

The sizing guide in the sales literature suggests average sizes that may be needed.

FAN CONTINUES TO RUN AFTER WATER HEATER OPERATION STOPS

It is the normal operation of the water heater for the fan to continue running after heating of the water is finished. The fan may run for up to six minutes after the burners extinguish, to prepare for the next ignition.

CLOUDS OF WHITE 'VAPOUR' FROM THE FLUE TERMINAL

During the heating cycle, it is not unusual to see water vapour clouds steaming from the flue terminal, particularly on cold days. This is normal operation of the water heater.

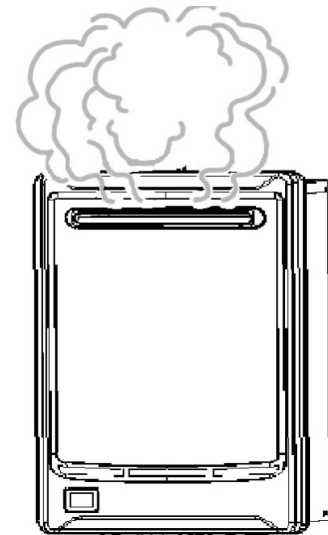

PRESSURE RELIEF VALVE DISCHARGING

A pressure relief valve is incorporated into the water heater controls. This valve protects the water heater, by allowing water to escape, in the event of excessive pressure build-up in the waterways.

- **Normal operation**

A small volume of water may discharge from the bottom of the water heater when a hot tap is suddenly closed.

- **Continuous dribble**

A continuous dribble may indicate the water supply pressure is above the design pressure for the water heater. If so, a pressure limiting valve must be installed on the cold water supply pipe to the water heater (refer to "[Mains Water Supply](#)" on page 21).

ERROR CODE

The water heater provides a diagnostic error code in the event of an interruption to its operation. The error code is displayed on the LED display on the front of the water heater as a numerical value. If an error code appears:

- Close the hot tap and switch off the electrical supply to the water heater.
- Check the gas isolation valve at the gas inlet to the water heater is fully open.
- Wait 5 minutes, then switch on the electrical supply to the water heater and open a hot tap.

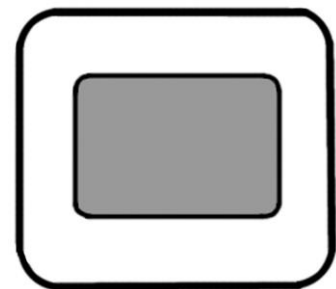

If the error code persists, take note of the numerical code and turn off the hot tap. Phone your nearest Solahart Dealer to arrange for inspection.

HIGHER THAN EXPECTED GAS BILLS

Should you at any time, feel your gas bill is higher than expected, we suggest you check the following points:

- Is one outlet (especially the shower) using more hot water than you think?

Carefully review the family's hot water usage. Inexpensive flow control valves can be easily fitted to the shower outlets to reduce water usage.

- Is the in-series gas booster operating too frequently?

Refer to "[Gas Booster Operating Too Frequently](#)" on page 16.

- Has there been an increase in hot water usage?

An increase in hot water usage may result in an increase in booster operation.

- Has your water heating tariff rate been increased by your gas retailer since your previous bill?



IF YOU HAVE CHECKED ALL THE FOREGOING AND STILL BELIEVE YOU NEED ASSISTANCE, PHONE YOUR NEAREST SOLAHART DEALER.

INSTALLATION – WATER HEATER

**THIS WATER HEATER IS FOR OUTDOOR INSTALLATION ONLY.
THIS WATER HEATER IS NOT SUITABLE FOR POOL HEATING.
Check the water heater is suitable for the gas type available.
(refer to the rating label on the water heater)**

INSTALLATION STANDARDS

The water heater must be installed:

- by a qualified person, and
- in accordance with the installation instructions, and
- in compliance with the Plumbing Code of Australia (PCA), Standards AS/NZS 3500.4 and AS/NZS 5601.1, and all local codes and regulatory authority requirements.
 - The Gas installations Standard AS/NZS 5601.1 places limitations on the location of a gas water heater within a covered area. Refer to [“Installation within a Covered Area”](#) on page 20.

⚠ Warning: This water heater may deliver water at high temperature. Refer to the Plumbing Code of Australia, local requirements and these installation instructions to determine if additional delivery temperature control is required. Refer to [“Hot Water Delivery”](#) on page 21.

All packaging must be removed from the water heater prior to its installation.

WATER HEATER APPLICATION

This water heater is designed for use in a single family domestic dwelling for the purpose of heating potable water. Its use in an application other than this may shorten its life.

If this water heater is to be used where an uninterrupted hot water supply is necessary for the application or business, then there should be back-up redundancy within the hot water system design. This should ensure the continuity of hot water supply in the event that this water heater was to become inoperable for any reason. We recommend you provide advice to the system owner about their needs and building back-up redundancy into the hot water supply system.

This water heater is suitable for use with a solar water heater with an over temperature protection system. If the solar water heater does not have an over temperature protection system, then a solar transfer valve should be installed.

Note: AS 3498 requires that a water heater provides the means to inhibit the growth of Legionella bacteria in potable water. When this water heater is used as an in-series booster for a solar water heater it can satisfy this AS 3498 requirement provided it is energised, the booster preset outlet temperature setting is 70°C or higher, and that a remote temperature controller is not used.

The factory preset outlet temperature setting of the in-series gas booster is 60°C. The preset outlet temperature setting can be adjusted (refer to [“Preset Outlet Temperature Setting”](#) on page 37).

WATER HEATER LOCATION

The water heater is suitable for outdoor installation only and should be installed close to the most frequently used outlet and the solar storage tank, with its position chosen with safety and service in mind. Make sure people (particularly children) will not touch the flue terminal. The flue terminal and air inlet must be clear of obstructions and shrubbery.

Clearance must be allowed for servicing of the water heater. The water heater must be accessible without the use of a ladder or scaffold. Make sure the entire front panel can be removed for service. You must be able to read the information on the rating plate. Remember you may have to take the entire water heater out later for servicing.



This water heater must be installed vertically upright with the water, gas and power connections on the underside, pointing toward the ground. The back of the water heater can be either against a wall or supported by a frame.

Note: The water heater must be well secured to the wall or frame using two fasteners each at the top and bottom of the unit (refer to page 24 for mounting hole positions and weight of the water heater). Use the screws provided only if they are suitable for the wall or frame type. Otherwise select and use alternative fasteners suitable for the application. The fasteners must be capable of bearing the full weight of the water heater so it may not work loose nor impose any load on the gas and water pipe work connected to the water heater. Refer to the fastener manufacturer’s information and recommendations for the type of fastener to use for the wall or frame type and load bearing requirements.

Alternatively the water heater can be recessed into a wall (refer to “[Recess Installation](#)” on page 20).

For a single water heater installation, refer to the typical installation diagrams on page 25.

For a multiple water heater installation, follow the [instructions](#) on pages 29 to 31.

The water heater must not be installed in an area with a corrosive atmosphere where chemicals are stored or where aerosol propellants are released. Remember the air may be safe to breathe, but when it goes through a flame, chemical changes take place which may attack the water heater.

A secondary flue is not required. The water heater must not be installed indoors or in a confined space.

The water heater must be located to ensure that the location of the flue terminal complies with the requirements of AS/NZS 5601.1. As a guide the following requirements are extracted from the Gas Installations Standard. The distances are measured along the wall behind the water heater.

- At least 300 mm between the top of the flue terminal and the eaves.
- At least 300 mm between the flue terminal and the edge of any opening into the building, such as an openable door or window, measured horizontally*.
- At least 1500 mm between the top of the flue terminal and the edge of any opening into the building, such as an openable window, measured vertically.
- At least 300 mm between the flue terminal and a return wall or external corner, measured horizontally*.
- At least 1500 mm between the flue terminal and any opening into a building, in the direction of the flue discharge.
- At least 500 mm between the flue terminal and a fence, wall or other obstruction, in the direction of the flue discharge.

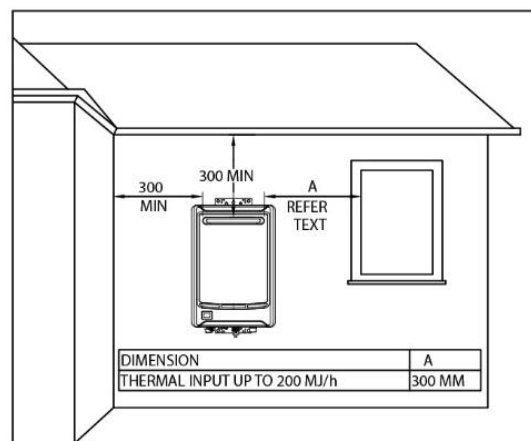

Note: * If these horizontal distances cannot be achieved, AS/NZS 5601.1 states an equivalent horizontal distance measured diagonally from the nearest discharge point of the flue terminal to the opening may be deemed to comply. Check with the local regulator.

INSTALLATION WITHIN A COVERED AREA

The water heater must be located such that the installation meets the requirements of AS/NZS 5601.1. There must be sufficient ventilation so the water heater has an adequate supply of combustion air and the flue products are dispersed safely. It is the licensed installer's responsibility to ensure the installation complies with the relevant sections of the Gas installations Standard.

Installation of this water heater is permitted within a covered area open on at least two sides, if its flue terminal is located to ensure a free flow of air across it is achieved.

AS/NZS 5601.1 also allows the installation of a continuous flow gas water heater within a covered area open on one side only if:

- the flue terminal is within 500 mm of the opening and is discharging in the direction of the opening, and
- there is no other flue terminal, gas meter, electricity meter, fuse box or opening into the building along the wall within the 500 mm distance, and
- the terminal is located to ensure a free flow of air across it is achieved.

Additional clearances to openings into the building or obstructions also apply, refer to AS/NZS 5601.1, Fig 6.2.

PIPE COVER

The pipe work to the water heater can be housed within a pipe cover. A pipe cover kit (PN 299426) is available for such an installation. Refer to the installation instructions which accompany the pipe cover kit.

Note: The pipe cover is available with a light grey finish only.

RECESS INSTALLATION

The water heater can be installed recessed into a wall. A recess box (PN 299427) is available for such an installation. Refer to the installation instructions which accompany the recess box kit for information on its installation.

The rating plate on the side of the water heater should be moved to or the information on it, including the water heater serial number, manufacture date and model number, indelibly copied onto either the front panel of the water heater or to another position which is visible when the water heater is installed so the householder or responsible officer can access the water heater details when required. An additional rating label is supplied attached to the inside of the front cover of the water heater. This is for a service person to access the water heater details when required.

Note: If the recess box is installed under a covered area, refer to ["Installation within a Covered Area"](#) on page 20.

FROST PROTECTION

The in-series gas booster has a frost protection system. The frost protection system will protect the in-series gas booster from damage, by preventing ice forming in the waterways of the in-series gas booster, in the event of freezing conditions occurring.

The frost protection system will be rendered inoperable if electrical power is not available at the water heater. Damage to the water heater caused by freezing of the pipe work to or from the water heater is not covered under the Solahart warranty. Refer to AS/NZS 3500.4 for precautions to be taken for installations in frost prone areas. The water heater is not suitable for installation in areas where the ambient temperature falls below -20°C (including wind chill factor).

The solar preheat line to the water heater must be insulated with suitable thickness insulation if freezing conditions are likely to occur. The insulation must be fitted to the underside of the water heater and be weatherproof and UV resistant if exposed.

MAINS WATER SUPPLY

Where the mains water supply pressure exceeds that shown in the table an approved pressure limiting valve is required and should be fitted prior to the solar storage tank. The solar storage tank may have a lower mains supply pressure requirement, which would govern the maximum supply pressure to the system.

Model	26
Relief valve setting	1750 kPa
Maximum mains supply pressure	1000 kPa
Minimum mains supply pressure *	120 kPa

* minimum water supply pressure required to achieve the rated flow and performance

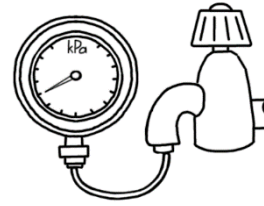

If the water heater is installed as a stand-alone water heater and not as an in-series gas booster to a solar water heater and the mains water supply pressure exceeds that shown in the table, an approved pressure limiting valve that does not have non-return valve characteristics (such as an RMC PSL series valve) must be installed and should be fitted as shown in the [water and gas connection detail diagram](#) on page 26.

Notes

- It is not recommended to install this water heater with a low pressure water supply.
- A minimum water supply pressure of 120 kPa is required to achieve the rated flow and performance of the water heater.
- The maximum water supply pressure to the solar water heater, without an expansion control valve (ECV), is generally 800 kPa, however it may be less than this for some models. Refer to the Owner’s Guide and Installation Instructions supplied with the solar water heater for maximum mains supply pressure details.
- If sludge or foreign matter is present in the water supply, it is recommended a suitable filter be incorporated in the cold water line to the water heater.
- This water heater is not suitable for connection to bore water or spring water unless a water treatment device is fitted.
- Refer to “[Water Supplies](#)” on page 14 for further information on water chemistry.

REDUCING HEAT LOSSES

The hot water line from the in-series gas booster and the pipe work between the solar storage tank and the in-series gas booster must be insulated in accordance with the requirements of AS/NZS 3500.4. The insulation must be weatherproof and UV resistant if exposed. The insulation must be fitted up to the connections on the both the underside of the water heater and the solar storage tank.

HOT WATER DELIVERY

This water heater used as a booster to a solar water heater can deliver hot water at a temperature up to and at times exceeding 70°C, sufficiently hot to cause severe scalding. Water at these temperatures may be plumbed to fixtures where water hotter than 50°C is allowed, such as the kitchen and laundry.

The installing plumber may have a legal obligation to ensure the installation of this water heater meets the delivery water temperature requirements of the Plumbing Code of Australia so that scalding water temperatures are not delivered to a bathroom, ensuite or other ablution or public area.

It is necessary and we recommend that a temperature limiting device be fitted between the water heater and the hot water outlets in any ablution and public areas such as a bathroom, ensuite or public amenities, to reduce the risk of scalding. The temperature limiting device must be of a type suitable for use with both a continuous flow water heater and a solar water heater. Refer to the manufacturer’s specifications of the temperature limiting device.

⚠ Warning: Temperature controllers **must not** be fitted to this water heater as part of a solar water heater system because water at a temperature much higher than the controller setting can be delivered.

Where a temperature limiting device is installed adjacent to the in-series gas booster, the cold water line to the temperature limiting device can be branched off the cold water line either before or after the isolation valve and pressure limiting valve to the solar storage tank, but it **MUST BE** before the non-return valve prior to an open circuit system. The cold water line to the temperature limiting device can be branched off the cold water line either before or after the non-return valve prior to a closed circuit system. If an expansion control valve is required, it must always be installed after the non-return valve and be the last valve prior to the solar storage tank.

Warning: A non-return valve **MUST BE** installed on the cold water line to the solar storage tank **AFTER** the cold water branch to a temperature limiting device prior to an open circuit system.

If a combination isolation valve and non-return valve (duo or trio valve) is installed on the cold water line to an open circuit solar water heater and the cold water line to the temperature limiting device branches off after this valve, then a second non-return valve must be installed between the cold water branch and the solar storage tank.

If a pressure limiting valve is installed on the cold water line to the solar water heater and the cold water line to a temperature limiting device branches off before this valve or from another cold water line in the premises, then a pressure limiting valve of an equal pressure setting may be required prior to the temperature limiting device.

Refer to the installation instructions supplied with the solar storage tank for further information on the installation of the cold water valves in the cold supply pipework prior to the solar storage tank.

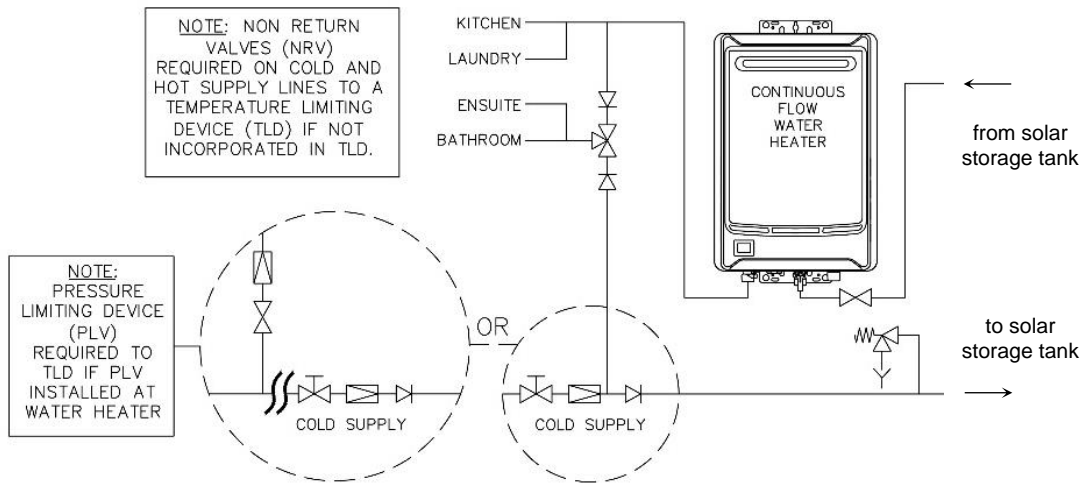

**In-series Gas Booster for Open Circuit Solar Water Heater Installation
Two Temperature Zones Using a Temperature Limiting Device**

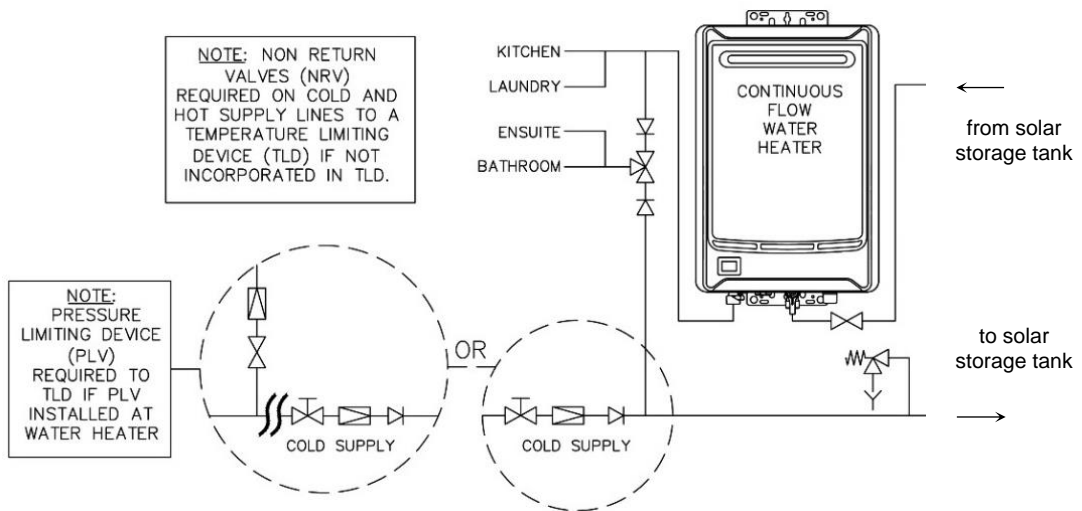

**In-series Gas Booster as part of a Closed Circuit Solar Water Heater Installation
Two Temperature Zones Using a Temperature Limiting Device**

CIRCULATED HOT WATER FLOW AND RETURN SYSTEM

A Solahart in-series gas booster can be installed as part of a circulated hot water flow and return system in a building.

Notes

- the preset outlet temperature setting of the water heater must be set to 70°C to meet the requirement of AS 3498, or to at least 60°C to meet the requirements of AS/NZS 3500.4.
- the return water temperature to the water heater must not be less than 55°C.

If the water temperature decreases to below 55°C due to heat loss from the ring main, the preset outlet temperature setting of the water heater must be increased to ensure the return water temperature is not less than 55°C.

The circulator must be:

- sized and set to provide a minimum flow rate of 3.0 L/min through the circulated hot water flow and return system, and
- either thermostatically and / or timer controlled.

The circulator **must not** be set to operate continuously, i.e. 24 hours per day.

Temperature Limiting Device

A temperature limiting device cannot be installed in circulated hot water flow and return pipe work. The tempered water from a temperature limiting device cannot be circulated. Where a circulated hot water flow and return system is required in a building, a temperature limiting device can only be installed on a dead leg, branching off the circulated hot water flow and return pipe.

If circulated tempered water were to be returned back to the water heater, depending on the location of the return line connection on the water supply line to the water heater, then either:

- water will be supplied to the cold water inlet of the temperature limiting device at a temperature exceeding the maximum recommended water supply temperature, or
- when the hot taps are closed no water will be supplied to the cold water inlet of the temperature limiting device whilst hot water will continue to be supplied to the hot water inlet of the temperature limiting device.

These conditions may result in either water at a temperature exceeding the requirements of AS/NZS 3500.4 being delivered to the hot water outlets in the ablution areas, or the device closing completely and not delivering water at all, or the device failing. Under either condition, the operation and performance of the device cannot be guaranteed.

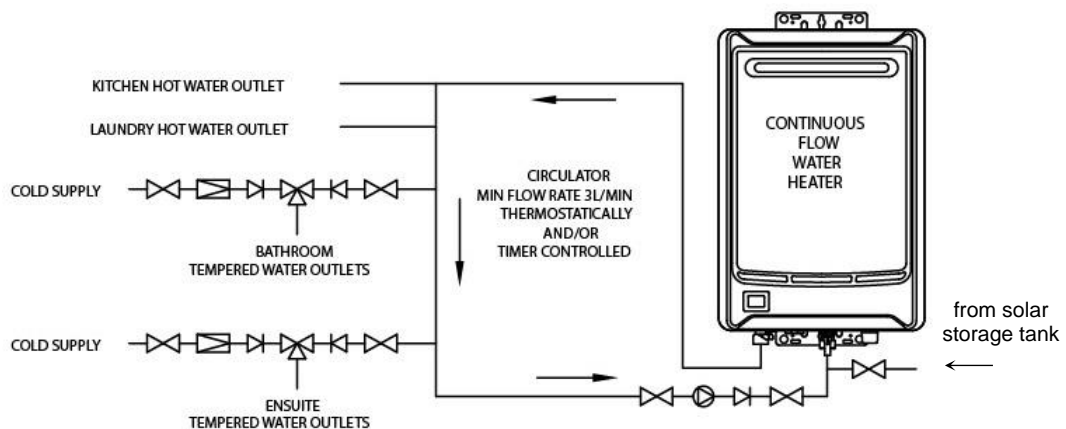

**Circulated Hot Water Flow and Return
In-series Gas Booster as part of a Solar Water Heater Installation**

DIMENSIONS AND TECHNICAL DATA – 26 LITRE MODELS

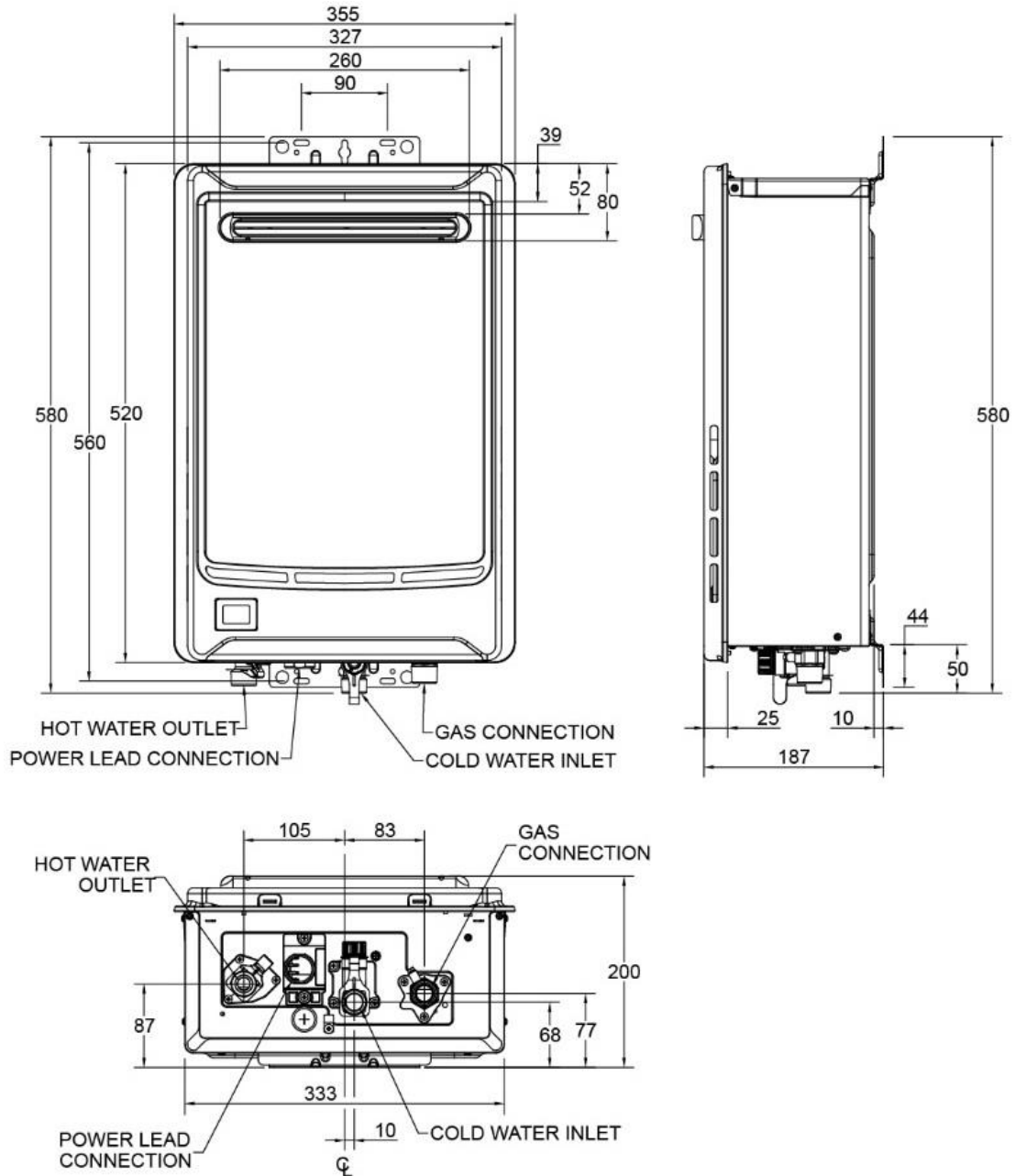

Model natural 10143268
 propane 10143267

Water heating capacity
 @ 40°C rise litres / min 16.2

Nominal capacity
 @ 25°C rise litres / min 26

Mass Empty (unpacked) kg 16

Gas Details	Hourly Gas Consumption (MJ)	Min Gas Pressure (kPa)	Test Point Gas Pressure (kPa)		Max Gas Pressure (kPa)	Injector Size (mm)
			minimum	maximum		
Model	26	26	26	26	26	26
Natural	199	1.13	0.15	0.92	3.50	20 x Ø 1.55 + 20 x Ø 1.03
Propane	199	2.75	0.19	0.98	3.50	20 x Ø 1.10 + 20 x Ø 0.73

Model numbers: 8 = Natural, 7 = Propane.

Digit 7, 8 is included in the part number as the eighth (last) digit, e.g. 10143268, to denote gas type.

Technical data is subject to change.

TYPICAL INSTALLATION – OUTDOOR LOCATION – 26 LITRE MODEL

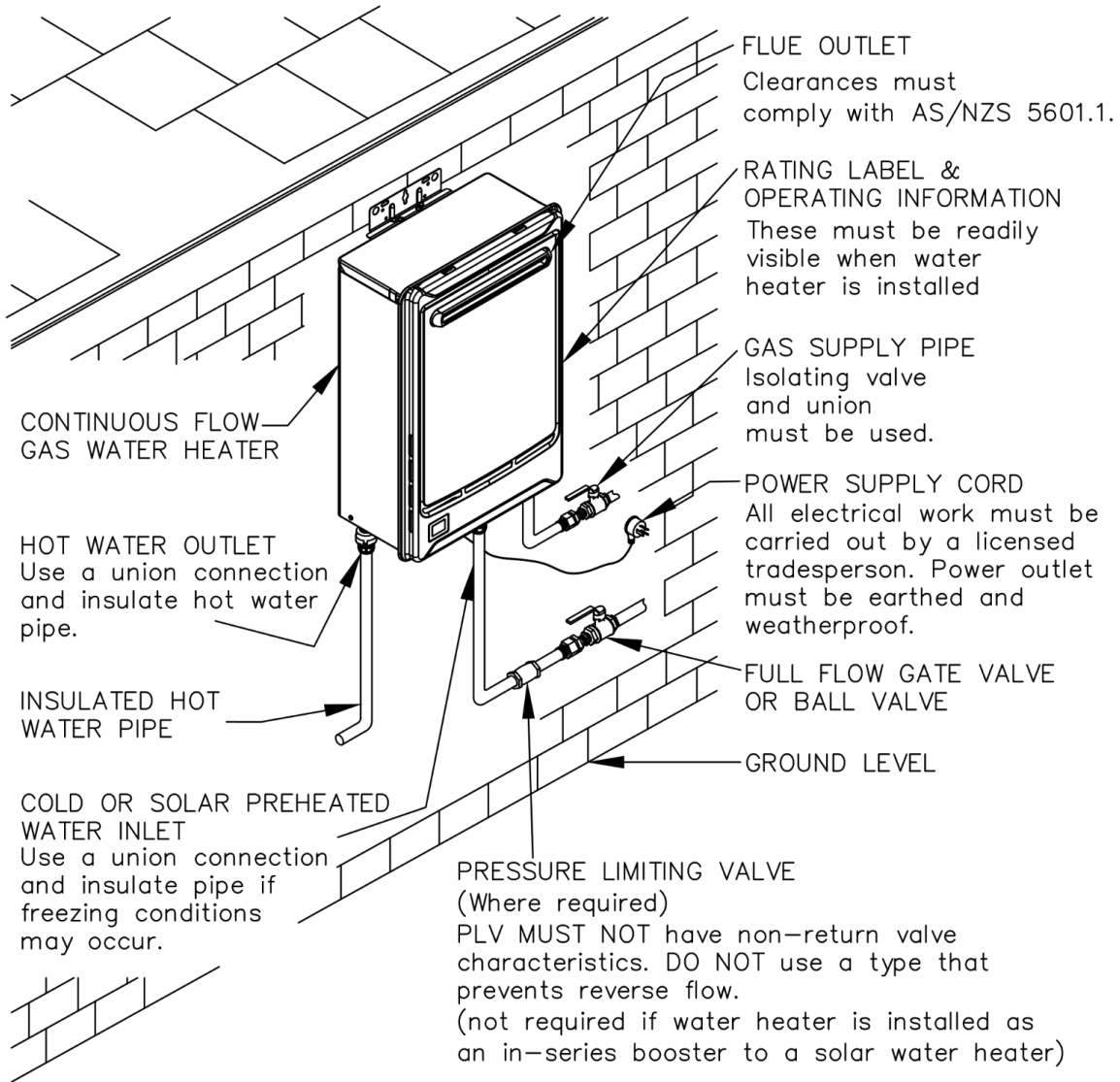

CONNECTIONS – PLUMBING

All plumbing work must be carried out by a qualified person and in compliance with the Standard AS/NZS 3500.4 and all local codes and regulatory authority requirements.

All gas work must be carried out by a qualified person and in compliance with the Standard AS/NZS 5601.1, all local codes and regulatory authority requirements.

CONNECTION SIZES

Hot water connection	R 3/4
Cold water connection	R 3/4
Gas inlet connection	R 3/4

WATER INLET AND OUTLET

All pipe work must be cleared of foreign matter before connection and purged before attempting to operate the water heater. All olive compression fittings must use brass or copper olives. Use an approved thread sealant such as Teflon tape on all threaded joints. Only use sufficient thread sealant to seal a joint. Refer to the sealant manufacturer's guidelines for how much and where to use.

⚠ Warning: Sealant must not be allowed in the waterways of pipe work or fittings. Excess sealant may be carried into the water heater where it will damage components and block the internal filters. This damage to components or blockage of filters is not covered by the Solahart warranty and a service rectification fee will be charged.

A full flow gate valve or ball valve must be installed on the cold water line or solar preheat water line to the water heater. **A non-return valve or stop tap must not be installed.** An acceptable arrangement is shown in the diagram. Refer also to [“Hot Water Delivery”](#) on page 21 and to [“Mains Water Supply”](#) on page 21.

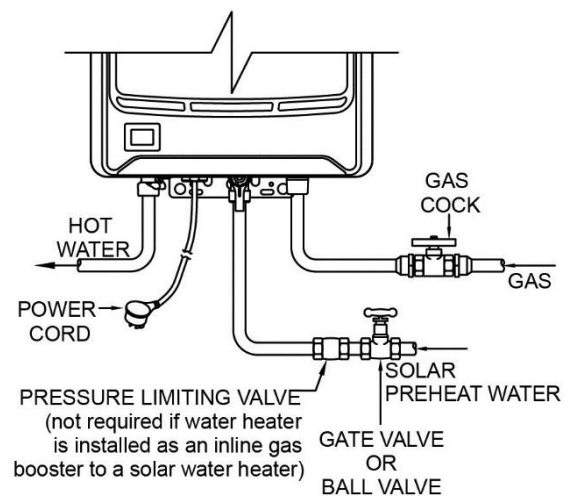

**In-series Gas Booster
Solar Preheat and Hot Water
and Gas Connection Details**

A disconnection union must always be provided at the cold water (solar preheat) inlet and hot water outlet on the water heater to allow for disconnection of the water heater.

Insulation used on the cold and hot water lines must extend up to the cold water (solar preheat) inlet and hot water outlet of the water heater.

This water heater is intended to be permanently connected to the water mains and not connected by a hose-set. A braided flexible hose or semi-flexible connector may be used for connection to the water heater, where permitted by AS/NZS 3500.4.

Notes

- It is essential all pipe connections be correctly aligned, otherwise component connections within the water heater may be strained and / or components themselves misaligned. It is recommended also, wherever possible, pipe connections be made at the water heater first and final pipe runs be made in soft copper pipe to allow some adjustment for misalignment.
- Use the spanner flats on the water heater fittings and take care to avoid twisting the water inlet and outlet pipes inside the jacket.

PIPE SIZES

The pipe sizing for hot water supply systems should be carried out by persons competent to do so, choosing the most suitable pipe size to ensure adequate flow for each individual application. Reference to the technical specifications of the water heater and local regulatory authority requirements must be made.

To achieve true mains pressure operation, the cold water line to the solar storage tank and from the solar storage tank to the in-series gas booster should be the same size or bigger than the hot water line from the water heater.

The minimum recommended solar preheat pipe and hot pipe size is DN20 for a single water heater installation. If more than one water heater is installed, refer to the table of [minimum header pipe sizes](#) on page 29.

The pipe work between the solar storage tank and the in-series gas booster **MUST BE** of copper and be fully insulated with a closed cell type insulation or equivalent in accordance with the requirements of AS/NZS 3500.4.

The insulation must be weatherproof and UV resistant if exposed. The insulation must be fitted up to the connections on both the solar storage tank and the in-series gas booster. A full flow isolation valve must be installed on the water line to the in-series gas booster.

GAS INLET

The gas connection is made at the underside of the water heater. The pipe work must be cleared of foreign matter before connection and purged before attempting to operate the water heater. An isolation valve and disconnection union must be installed to allow servicing and removal of the water heater (refer to the [diagram on page 26](#)).

Note: Refer to the Gas Installations Standard AS/NZS 5601.1 for the correct method of sizing the gas supply pipe to the water heater. The pipe size selection must take into account the high gas input of this water heater (refer to [table on page 24](#)) as well as all of the other gas appliances in the premises.

⚠ Warning: Always isolate the water heater before pressure testing the gas supply system. Disconnect the water heater after the isolation valve to prevent the risk of serious damage to the gas control. The Solahart warranty does not cover damage of any nature resulting from failure to observe this precaution. Refer to rating label for gas types and pressures.

CONNECTIONS – ELECTRICAL

All electrical work and permanent wiring must be carried out by a qualified person and in accordance with the Wiring Rules AS/NZS 3000 and all local codes and regulatory authority requirements.

⚠ Warning: Temperature controllers **must not** be fitted to this water heater as part of a solar water heater system because water at a temperature much higher than the controller setting can be delivered.

The water heater is supplied with a 1.8 metre lead and plug and requires a weatherproof 220 V - 240 V a.c. 50 Hz general purpose outlet (GPO) to be located within 1.2 metres of the installation. The GPO must be clear of the flue exhaust, draining water, gas supply pipe and water connections.

The power consumption of the water heater is:

26L Model	Power consumption	Comments
Natural gas	54 Watts	Burner on, anti-frost device inactive
Propane gas	59 Watts	Burner on, anti-frost device inactive
Natural gas	122 Watts	Burner on, anti-frost device active
Propane gas	127 Watts	Burner on, anti-frost device active

The water heater will only operate on a sine wave at 50 Hz. Devices generating a square wave cannot be used to supply power to the water heater.

WIRING DIAGRAM

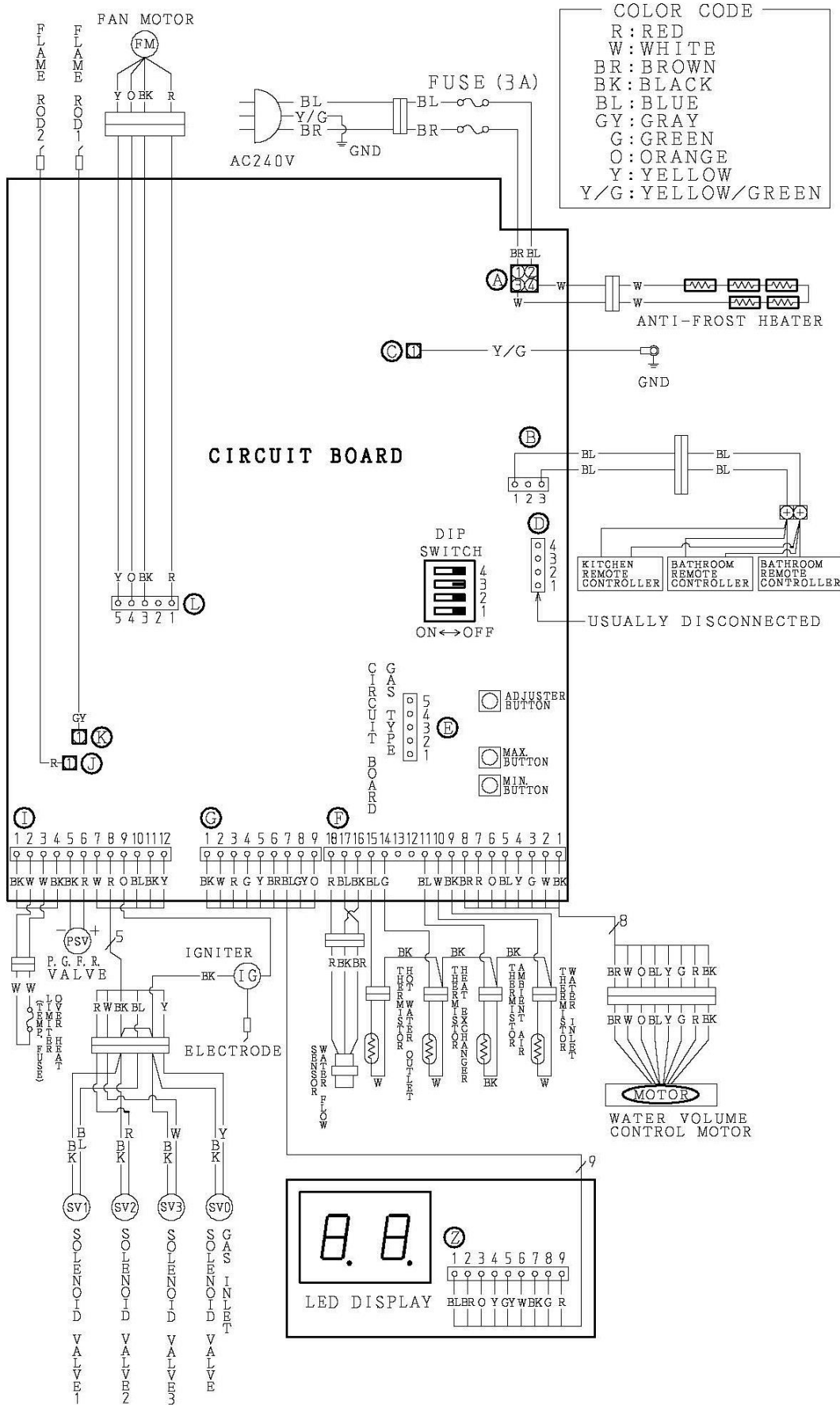

P. G. F. R. VALVE: PROPORTIONAL GAS FLOW REGULATING VALVE

MULTIPLE INSTALLATIONS

A multiple installation of Solahart 26 litre in-series gas boosters on a single manifold is possible, using a parallel plumbing arrangement, where large volumes of hot water are required. It is good practice, but not essential, to install the water heaters in an Equa-Flow® plumbing arrangement. The installation may operate on a dead leg system or a circulated flow and return system.

If a circulated flow and return system is installed, the circulator must be sized and set to provide a minimum flow rate of 3.0 L/min through the circulated hot water flow and return system and be either thermostatically and / or timer controlled. The circulator must not be set to operate continuously, i.e. 24 hours per day.

The solar preheat water and hot water manifolds must be designed to balance the flow from each water heater. To achieve this, there are basic installation requirements and principles which must be followed:

1. The maximum number of water heaters in a bank should be 6. Only one bank can be installed.
2. The water heaters must be of the same model.
3. The solar preheat water line, solar preheat and hot headers and hot water line must be sized to meet the requirements of both AS/NZS 3500.4 and the application. The gas line must be sized to meet the requirements of AS/NZS 5601.1 and the application.

Minimum header pipe sizes at the installation are:

No of water heaters	1	2	3	4	5	6
Solar preheat and hot header pipe size	DN20	DN25	DN32	DN32	DN40	DN40
Gas pipe size	DN20	DN25	DN32	DN32	DN40	DN40

Note: Water and gas supply pipe sizes to the installation may be required to be larger than the minimum pipe sizes at the installation to meet the requirements of the Standards and the application.

The recommended branch line size for the solar preheat and hot water and gas pipes is DN20.

4. A full flow gate valve or ball valve is not required to be installed on the solar preheat water line to the system. A non-return valve or stop tap must not be installed.
5. A full flow gate valve or ball valve (not a stop tap) must be installed on both the inlet and outlet branches of each water heater. A non-return valve must not be installed.
6. An isolation valve must be installed on the gas branch of each water heater.
7. An adjustable pressure reducing valve (PRV) (RMC model PRV020) must be installed on the solar preheat branch to all but the first water heater.

Each PRV is to be adjusted so that each subsequent water heater is staged to operate only after the required hot water flow rate increases by intervals of 13 litres per minute (refer to [“Pressure Reducing Valve Commissioning Procedure”](#) on page 32).

8. Non-return valves or pressure limiting valves must not be installed on the branch lines to the water heaters.
9. It is good plumbing practice for all fittings, valves and branch lines to be matched sets all the way along the manifold.
10. Sufficient space must be left to enable access, servicing or removal of any water heater.

RATING LABEL INFORMATION

There is information on the rating label located on the right hand side of the water heater, which may be required for future warranty and service requirements. This information will be hidden on all but the right hand water heater if multiple water heaters are installed with minimal clearance between them.

Move the rating label to or indelibly copy the water heater serial number, manufacture date and model number from the label onto the front panel of all but the right hand water heater or to another position which is visible when the water heaters are installed so these details can be accessed when required.

A second rating label is attached to the inside of the front cover. This is for a service person to access the water heater details when required.

SELECTION AND INSTALLATION

The water heaters can be installed side by side with minimal clearance between them. The water heaters are certified for installation with an exemption from the 300 mm minimum clearance requirements between flue terminals, as stated in AS/NZS 5601.1 clause 6.9.3.

The water heater installation should be sized and the number of water heaters selected to cater for the cold water temperature in winter and assuming a period of no solar gain without any solar heated water available. The climate chart is based on a flow rate from a shower outlet not exceeding 9 litres per minute and a tempered water temperature of 42°C.

Climate Chart	Number of Shower Outlets – 26L Models																		
	1	2	3	4	5	6	7	8	9	10	11	12	13	14	15	16	17	18	19
number of water heaters warm / tropical climate (20°C inlet temperature)	1	1	1	2	2	2	3	3	3	4	4	4	4	5	5	5	6	6	6
number of water heaters moderate climate (15°C inlet temperature)	1	1	2	2	2	3	3	3	4	4	5	5	5	6	6	6	-	-	-
number of water heaters cool climate (10°C inlet temperature)	1	1	2	2	3	3	4	4	4	5	5	6	6	-	-	-	-	-	-

Note: If there are other hot water outlets which may operate simultaneously with the shower outlets, then the operation and flow rates of these outlets need to be considered and an allowance made when selecting the number of water heaters for the application.

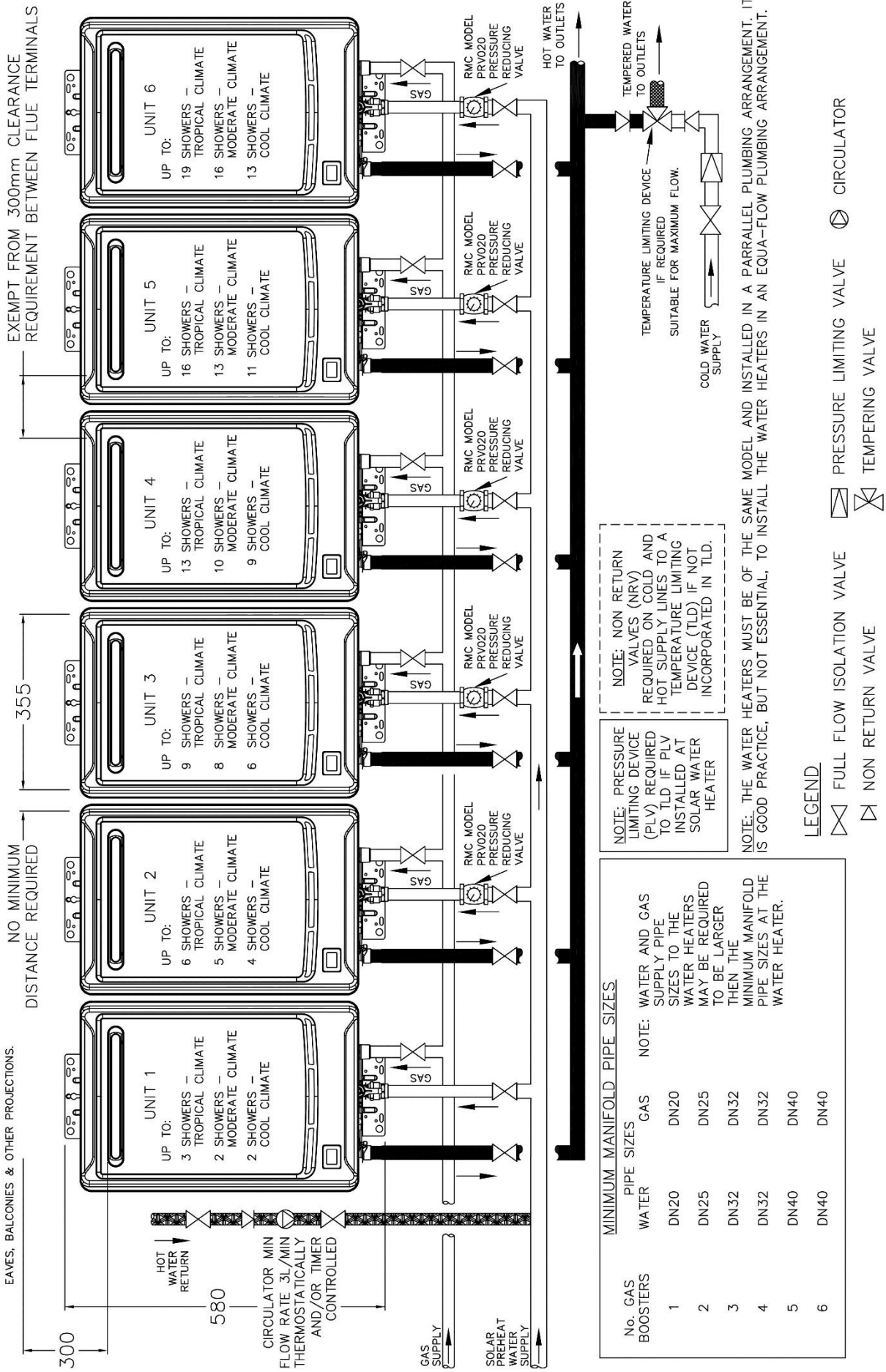

MINIMUM MANIFOLD PIPE SIZES

No. GAS BOOSTERS	PIPE SIZES	WATER	GAS	NOTE: WATER AND GAS SUPPLY PIPE SIZES TO THE WATER HEATERS MAY BE REQUIRED TO BE LARGER THEN THE MINIMUM MANIFOLD PIPE SIZES AT THE WATER HEATER.
1	DN20	DN20	DN20	
2	DN25	DN25	DN25	
3	DN32	DN32	DN32	
4	DN32	DN32	DN32	
5	DN40	DN40	DN40	
6	DN40	DN40	DN40	

TYPICAL INSTALLATION – MULTIPLE GAS BOOSTER WATER HEATERS

PRESSURE REDUCING VALVE COMMISSIONING PROCEDURE

The pressure reducing valves must be set and commissioned for each water heater so the water heaters will turn on and off in sequence when the flow rate increases or decreases to a particular rate. This procedure can be conducted with either cold water or solar heated water, however the temperature of the solar heated water must not exceed 58°C.

To set and commission the pressure reducing valves:

1. **Commissioning:** Commission each of the water heaters prior to setting the pressure reducing valve on the solar preheat branch to the water heater (refer to “[Commissioning](#)” on page 33).
2. **Turn on services:** Turn on the water, gas and electricity to the water heaters.
3. **Locking screw:** Loosen the locking screw on each PRV020 valve with a flat bladed screw driver.
 - To adjust the PRV020 valve during this commissioning procedure, turn the knob:
 - **Anti-clockwise** = delay unit ignition
 - **Clockwise** = bring forward unit ignition
4. **Open a hot tap:** Open 1 x hot shower or tap to between 7-8 litres / min. The first water heater (without PRV020 valve) should ignite and provide hot water.

Notes

- The flow rate from each shower or tap throughout this commissioning procedure should be between 7-8 litres / min.
 - When turned on, each shower or tap must be at an equal flow rate.
5. **Temperature limiting device:** Set the temperature of any temperature limiting device installed downstream of the manifold.
 6. **First water heater:** Open the maximum number of showers suitable for 1 x water heater in accordance with the climate chart. Only the first water heater should be operating.

If other water heaters are operating, adjust their PRV020 valves by turning the knob anti-clockwise until the water heater turns off.
 7. **Second water heater:** Open the next shower. The second water heater should ignite.

If it fails to ignite, adjust the PRV020 valve by turning the knob clockwise until the water heater turns on.

If other water heaters ignite, adjust their PRV020 valves by turning the knob anti-clockwise until the water heater turns off.
 8. Turn off the previous shower. The second water heater should turn off.

If it does not turn off, adjust the PRV020 valve by turning the knob anti-clockwise until the water heater turns off.
 9. Open the maximum number of showers suitable for 2 x water heaters, in accordance with the climate chart. Only the first two water heaters should be operating.

If other water heaters downstream are operating, adjust their PRV020 valves by turning the knob anti-clockwise until the water heater turns off.
 10. **Subsequent water heaters:** Repeat steps 7 to 9 for each subsequent water heater in the bank.
 11. **Locking screw:** Turn off all showers and lock adjusting screw on the PRV020 valves. Commissioning is now complete.

COMMISSIONING

All water heaters are tested and adjusted before dispatch from the factory, however further adjustments may become necessary because of local conditions.

Note: If this water heater is installed as part of a multiple installation, i.e. in a bank of water heaters, it will be necessary to isolate the other water heaters and commission the water heaters one at a time. However, all the water heaters will need to be operating during the checking of the gas pressure.

TO TURN ON THE WATER HEATER

- Open all of the hot taps in the house (don't forget the shower).
- Open the cold water isolation valve fully at the inlet to the solar water heater.
- Open the solar heated water isolation valve fully at the inlet to the in-series gas booster.

Air will be forced out of the taps.

- Close each tap as water flows freely from it.
- Check the pipe work for leaks.
- Open the gas isolation valve fully.
- Check the gas pipe work for leaks.
- Plug in the water heater at the power outlet and switch on the electrical supply.
- Open a hot tap.

The water heater will operate automatically.

- Check to ensure the flow from each connected hot tap is sufficient to operate the water heater.

The minimum operating flow rate is 2.0 L / min (26L models).

- Check and if required adjust the preset outlet temperature setting of the water heater.

Refer to "[Preset Outlet Temperature Setting](#)" on page 37.

The automatic water governor incorporated in the water heater is not adjustable.

To complete the installation, it is necessary to check the gas supply pressure at the inlet to the water heater (refer to "[Gas Inlet Pressure](#)" on page 33), the minimum test point pressure and the maximum test point pressure (refer to "[Burner Gas Pressure](#)" on page 35).

Explain to the householder or a responsible officer the functions and operation of the water heater and the solar water heater system.

⚠ Warning: Upon completion of the installation and commissioning of the water heater, leave this guide with the householder or a responsible officer. **DO NOT** leave this guide inside of the cover of the water heater, as it may interfere with the safe operation of the water heater or ignite when the water heater is turned on.

GAS INLET PRESSURE

IMPORTANT - CHECK the gas supply pressure at the inlet to the water heater with the water heater and all other gas burning appliances in the premises operating (burners alight). The minimum gas supply pressure is:

Natural Gas	1.13 kPa	Propane	2.75 kPa
-------------	----------	---------	----------

If this minimum cannot be achieved, it may indicate the meter or the gas line to the water heater is undersized. It is important to ensure that an adequate gas supply pressure is available to the water heater when other gas burning appliances, on the same gas supply, are operating.

Gas Inlet Test Point Pressure

To check the gas inlet pressure:

1. Close any hot taps and ensure the burners are not operating.
2. Close the gas isolation valve at the gas inlet to the water heater.
3. Locate the gas inlet test point on the gas connection to the water heater.
 - Remove the test point screw and washer from the test point orifice.
 - Connect the manometer.
4. Open the gas isolation valve fully at the gas inlet to the water heater.
5. Observe the gas pressure reading on the manometer.

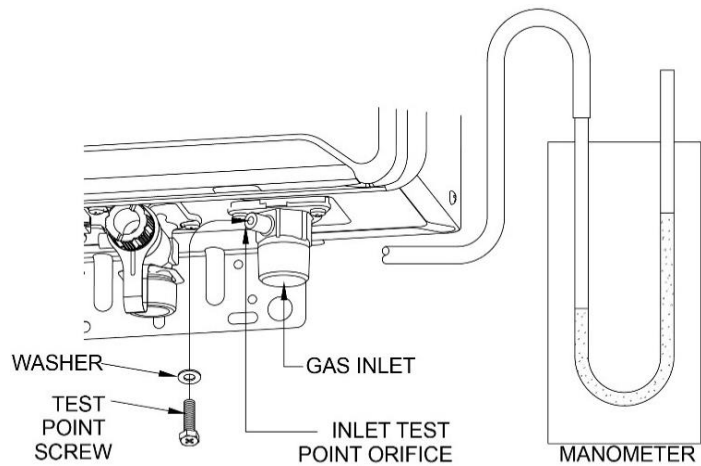

If the manometer reading is between the minimum and maximum inlet gas pressure ratings on the rating label, no adjustment is required.

If the manometer reading is below the minimum inlet gas pressure rating on the rating label, then either the gas pipe to the water heater is undersized and needs to be rectified or adjustment is required at the gas regulator.

If the manometer reading is above the maximum inlet gas pressure ratings on the rating label, then adjustment is required at the gas regulator.

6. Switch on the electrical supply at the power outlet to the water heater if it is not already switched on.
7. Open a hot tap fully and ensure the burners are fully ignited.

It may be necessary to open a second tap.
8. Turn on all other gas burning appliances in the house which are on the same gas supply.
9. Observe the gas pressure reading on the manometer.

If the manometer reading is between the minimum and maximum inlet gas pressure ratings on the rating label, no adjustment is required.

If the manometer reading is below the minimum inlet gas pressure rating on the rating label, then either the gas pipe to the water heater is undersized and needs to be rectified or adjustment is required at the gas regulator.

If the manometer reading is above the maximum inlet gas pressure ratings on the rating label, then adjustment is required at the gas regulator.

10. Turn off the other gas burning appliances in the house.
11. If an adjustment was made during Step 9, repeat this procedure from Step 5.
12. Close the hot tap(s).
13. Close the gas isolation valve at the inlet to the water heater.
14. Remove the manometer and refit and tighten the test point screw and washer.
15. Open the gas isolation valve fully at the gas inlet to the water heater.
16. Open a hot tap again so the burners ignite.
17. Test for gas leaks.
18. Close the hot tap.

BURNER GAS PRESSURE

It is necessary to check the burner gas pressure at both the minimum and maximum operational settings. To check and if necessary adjust the operational gas pressures, the electrical supply to the water heater must be switched on, the burners ignited and hot water must be flowing from a hot tap.

⚠ Warning: The removal of the front panel will expose 220 V - 240 V a.c. wiring. Take care not to touch wiring terminals.

Note: The temperature of the water entering the in-series gas booster must be below 58°C, otherwise the gas burners will not ignite and the operational gas pressures cannot be measured.

Minimum test point gas pressure

Refer to the rating label on the water heater for the minimum test point gas pressure.

1. Close any hot taps and ensure the burners are not operating.
2. Switch off the electrical supply at the power outlet to the water heater.
3. Remove the top and bottom cover strips to gain access to the front panel screws by pressing on the two ridged finger points and gently pulling forward.
4. Remove the screws holding the front panel to the jacket.
5. Gently disengage the front panel and pull forward to remove from the water heater.
6. Locate the burner pressure test point on the main burner manifold
 - Remove the test point screw and washer from the test point orifice.
 - Connect the manometer.
7. Switch on the electrical supply at the power outlet to the water heater.
8. Open the gas isolation valve fully at the gas inlet to the water heater, if not already open.
9. Open a hot tap slowly until the burners ignite.
10. Press and hold down the MIN button and observe the reading on the manometer.
 - "1L" is shown on the LED display.
11. Release the MIN button.

If the manometer reading observed in step 10 agrees with the rating label, no further adjustment is required.

12. To adjust, press and hold down the adjuster button.
 - "LH" is shown on the controller display.

Note: The adjuster button must be held down continuously through steps 12 to 14.

13. Press and hold down the MIN button and observe the reading on the manometer.
 - The manometer reading will change as the test point gas pressure adjusts.

Note: While the MIN button is pressed, the gas pressure will at first increase then decrease, cycling between an upper gas pressure limit (59 on the LED display) and a lower gas pressure limit (01 on the LED display).

14. Release the MIN button when the reading on the manometer agrees with the rating label.
15. Release the adjuster button.

Refer to [Notes](#) and "[Maximum test point gas pressure](#)" on page 36.

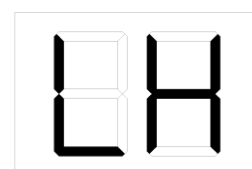
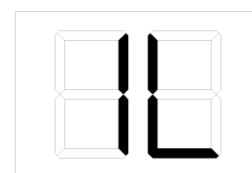
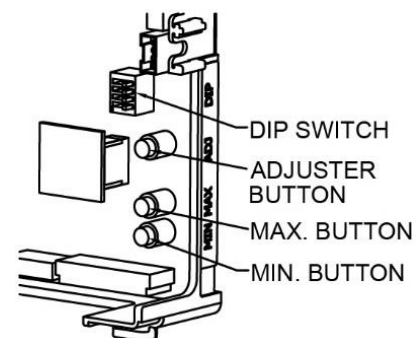
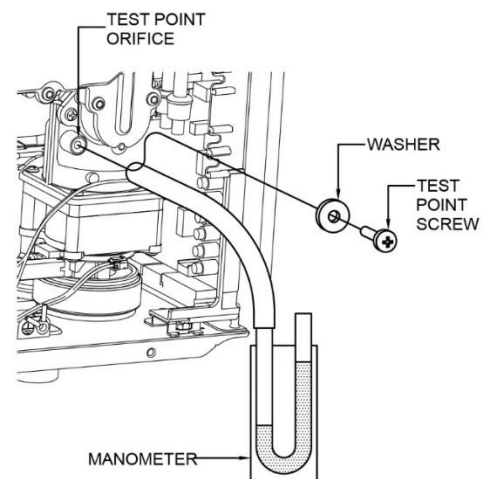

Notes

- If the burners extinguish and error code 11 or 12 starts to flash on the LED display:
 - release the MIN and adjuster buttons
 - close the hot tap
 - clear the error code (refer to [“Clearing Error Code”](#) on page 36)
 - recommence the procedure from Step 9.
- If the adjuster button is released before Step 14, clear any error code (if displayed) and recommence the procedure from Step 9.

Clearing Error Code

If an error code does appear on the LED display during the commissioning process, it will be necessary to clear the error in order to complete the installation. To clear an error code:

- Switch off the electrical supply at the power outlet to the water heater.
- Check the gas isolation valve at the gas inlet to the water heater is fully open.
- Wait five (5) minutes.
- Switch on the electrical supply at the power outlet to the water heater.

Maximum test point gas pressure

Refer to the rating label on the water heater for the maximum test point gas pressure.

Follow Steps 9 to 14 of the [“Minimum test point gas pressure”](#) procedure on page 35, but open the hot tap fully and use the MAX button instead of the MIN button.

It may be necessary to open two or three hot taps fully, depending upon the model of water heater and the incoming cold water temperature.

Notes

- In Step 10, “6H” will be shown on the LED display.
- In Step 13 While the MAX button is pressed, the gas pressure will at first increase then decrease, cycling between an upper gas pressure limit (39 on the LED display) and a lower gas pressure limit (01 on the LED display).

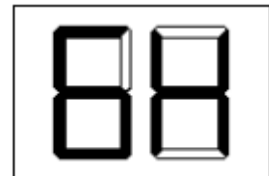

After setting the minimum and maximum test point gas pressures:

- Close the hot tap.
- Remove the manometer and refit and tighten the test point screw and washer.
- Open a hot tap again so the burners ignite.
- Test for gas leaks.
- Close the hot tap.
- Switch off the electrical supply at the power outlet to the water heater
- Refit the front panel and screws to the water heater.
- Refit the cover strips to the top and bottom of the front panel by inserting the two posts into the two recesses and gently pushing into position.

PRESET OUTLET TEMPERATURE SETTING

The factory preset outlet temperature setting of the in-series gas booster is 60°C. The preset outlet temperature setting can be adjusted. Refer to [“To Check or Adjust the Preset Outlet Temperature Setting”](#) on page 37.

Note: AS 3498 requires that a water heater provides the means to inhibit the growth of Legionella bacteria in potable water. When this water heater is used as an in-series booster for a solar water heater it can satisfy this AS 3498 requirement provided it is energised, the booster preset outlet temperature setting is 70°C or higher, and that a remote temperature controller is not used.

Note: Consideration must be given to the delivery temperature to any ablution and public areas such as a bathroom, ensuite or public amenities. Refer to [“Hot Water Delivery”](#) on page 21 and to the schematics of [Two Temperature Zones Using A Temperature Limiting Device](#) on page 22.

TO CHECK OR ADJUST THE PRESET OUTLET TEMPERATURE SETTING

The temperature setting will be displayed on the LED display. The preset outlet temperature settings are:

- 38°C, 40°C, 42°C, 43°C, 48°C, 50°C, 55°C, 60°C, 65°C, 70°C, 75°C

It is necessary to have the electrical supply to the water heater switched on during stages of checking or adjusting the preset outlet temperature setting procedure.

⚠ Warning: The removal of the front panel will expose 220 V - 240 V a.c. wiring. Take care not to touch wiring terminals. The adjustment must be carried out by a qualified person.

⚠ Warning: This procedure will involve the adjustment of dip switches. Adjustment of a dip switch should only be made with an insulated tool.

To check or adjust the preset outlet temperature setting:

1. Switch off the electrical supply at the power outlet to the water heater.
2. Remove the top and bottom cover strips to gain access to the front panel screws by pressing on the two ridged finger points and gently pulling forward.
3. Remove the screws holding the front panel to the jacket.
4. Gently disengage the front panel and pull forward to remove from the water heater.
5. Close the cold water isolation valve at the inlet to the water heater.
6. Switch on the electrical supply at the power outlet to the water heater.

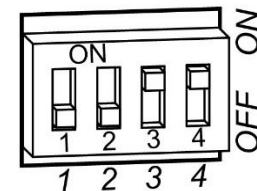

Note: Wait five (5) seconds for the electronic system to initialise.

7. Switch DIP switches 3 and 4 to the on (up) position on the PCB.

The current preset outlet temperature setting will show on the LED display.

If the temperature displayed on the LED display is the desired preset outlet temperature setting, then proceed to step 9, as no further adjustment is necessary.

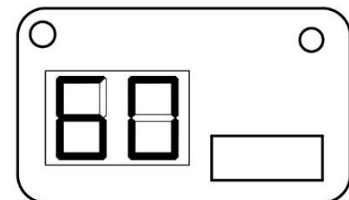

8. Press the MAX button to increase or the MIN button to decrease the preset outlet temperature setting.

Each press of the MAX or MIN button will increase or decrease the preset temperature by one increment.

The MAX and MIN buttons are located below the DIP switches and adjuster button.

The increments are 38°C, 40°C, 42°C, 43°C, 48°C, 50°C, 55°C, 60°C, 65°C, 70°C, 75°C.

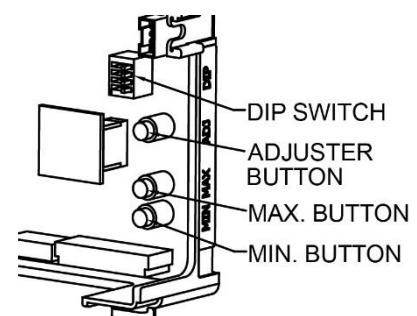

9. Switch DIP switches 3 and 4 to the off (down) position.

The LED display will go blank.

Note: Wait five (5) seconds for the setting to be saved. The preset outlet temperature setting is now set.

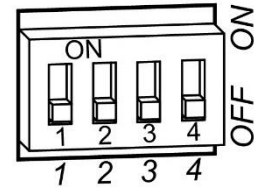

10. Switch off the electrical supply at the power outlet to the water heater.
11. Refit the front panel and screws to the water heater.
12. Refit the cover strips to the top and bottom of the front panel by inserting the two posts into the two recesses and gently pushing into position.
13. Open the cold water isolation valve fully at the inlet to the water heater.
14. Switch on the electrical supply at the power outlet to the water heater.

TO TURN OFF THE WATER HEATER

If it is necessary to turn off the water heater on completion of the installation, such as on a building site or where the premises is vacant, then:

- Switch off the electrical supply at the power outlet to the water heater (refer to note below).
- Close the gas isolation valve at the inlet to the water heater
- Close the solar heated water isolation valve at the inlet to the water heater.
- Drain the water heater if there is a risk of freezing conditions occurring (refer to [“Draining The Water Heater”](#) on page 39).

Notes

- The frost protection system will be rendered inoperable if electrical power is not available at the water heater.
- Damage caused by freezing due to the unavailability of power at the water heater is not covered by the Solahart warranty (refer to [“Terms of the Solahart Warranty”](#) on page 4).
- If the power has been switched off to the water heater and there is a risk of freezing, then it is necessary to drain the water heater (refer to [“Draining the Water Heater”](#) on page 39).

DRAINING THE WATER HEATER

To drain the water heater:

- Turn off the water heater (refer to “[Turn Off The Water Heater](#)” on page 38).
- Open a hot tap (preferably the shower outlet).
- Unscrew the two drain plugs, one each at the solar heated water inlet and hot water outlet, on the underside of the water heater.

Water will drain from the water heater.

- When water stops flowing from the water heater, close the hot tap.

Note: It is recommended not to screw the drain plugs back in, until the water heater is to be turned on again.

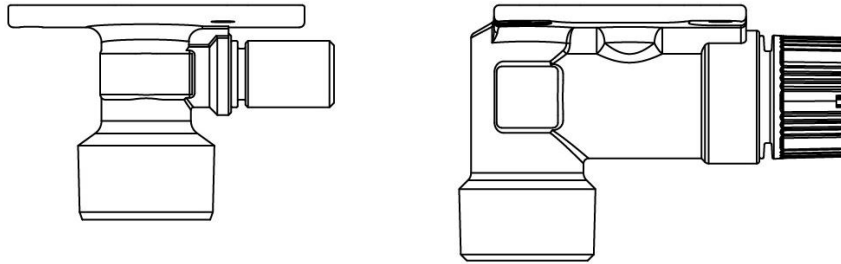

SOLAHART OFFICES

International Headquarters

Solahart Industries Pty Ltd
(ABN 45 064 945 848)

Registered Office
1 Alan Street
Rydalmere, New South Wales, 2116
Australia

Postal Address:
PO Box 7508
Rydalmere NSW 2128
Australia
www.solahart.com.au

Australia

For SERVICE Telephone - **1800 638 011**
or your nearest Solahart Dealer

For Sales Telephone - **1300 769 475**
or your nearest Solahart Dealer

International Sales

Telephone International Sales:
+ 61 8 9351 4600

Facsimile International Sales:
+ 61 8 9351 4698

Email:
solahart@solahart.com.au

Web:
www.solahart.com



41 169880000