

# *Installation Instructions*



## *Single-Phase PV Systems* **Solahart440BRB2 Silhouette Modules**

*Solahart PV Systems must be installed and serviced by a suitably qualified person.*

**⚠ Warning:** For continued safety of this PV System, it must be installed, operated and maintained in accordance with these instructions and the installation guide supplied with the PV inverter.

**⚠ Caution:** Only qualified and accredited personnel should perform work on PV systems, such as design, installation, commissioning, maintenance and repairs. Be sure to follow the safety instructions for all system components. It is also important to observe relevant local codes and regulations for health and safety and accident prevention.

**Only Solahart parts and Solahart approved parts may be used. No substitute parts may be used without prior approval from Solahart Industries Pty Ltd. Only parts supplied by Solahart Industries Pty Ltd are covered by the Solahart warranty.**

**The warranty can become void if safety devices are tampered with or if the installation is not in accordance with these instructions.**

---

#### **PATENTS**

This PV System may be protected by one or more patents or registered designs in the name of Solahart Industries Pty Ltd.

#### **TRADE MARKS**

® Registered trademark of Solahart Industries Pty Ltd.  
™ Trademark of Solahart Industries Pty Ltd.

**Note:** Every care has been taken to ensure accuracy in preparation of this publication. No liability can be accepted for any consequences, which may arise as a result of its application.

---

# CONTENTS

---

<b>Contents .....</b>	<b>3</b>
<b>Overview.....</b>	<b>4</b>
<b>Wiring Diagram.....</b>	<b>6</b>
<b>Earthing Arrangements – All Systems .....</b>	<b>13</b>
<b>Installation Procedure.....</b>	<b>14</b>
<b>Planning .....</b>	<b>15</b>
<b>Racking.....</b>	<b>21</b>
<b>Rooftop Isolator .....</b>	<b>39</b>
<b>Wiring .....</b>	<b>40</b>
<b>Power Optimisers (SolarEdge).....</b>	<b>42</b>
<b>Power Optimisers (TIGO).....</b>	<b>45</b>
<b>PV Modules .....</b>	<b>49</b>
<b>Inverter .....</b>	<b>54</b>
<b>Meter (SolarEdge Only).....</b>	<b>57</b>
<b>Labelling.....</b>	<b>58</b>
<b>Commissioning.....</b>	<b>62</b>
<b>Engineering Certification.....</b>	<b>66</b>

## OVERVIEW

---

The following installation instructions detail installation procedures for photovoltaic modules, power optimizers, inverter, module racking systems and balance of system (BOS) components.

Prior to the installation of any grid connected PV system, a Site Visit shall be performed in accordance with the Clean Energy Council's latest requirements.

### SAFETY REQUIREMENTS

The voltages and currents produced by a single module or modules connected in series (voltages added together) or in parallel (currents added together) can be dangerous.

Although module DC plug connectors are insulated to provide touch safe protection, the following points must be observed when handling modules in order to avoid the risk of sparking, fire hazard, burn risk, and lethal electric shocks:

- Exercise extreme caution when wiring modules and look out for damaged or split cable ends.
- Do not perform wiring work in rainy or damp conditions.
- Never insert metallic or otherwise conductive objects into plugs or sockets.
- Ensure that all electrical connections are completely dry and free from contaminants before they are assembled.
- Ensure that connections are tight and correctly made.
- Keep all materials, tools and work areas clean and dry.
- Do not connect any exposed cable ends. Do not touch poles at the same time.
- Always use appropriate safety equipment such as insulated tools and wear personal protective equipment such as insulated gloves.
- Solar modules produce current when exposed to sunlight. It is recommended that the system is shielded with an opaque cover during installation, maintenance or repair work.

The installation shall not be carried out alone.

### INSTALLER RESPONSIBILITIES

The installer is solely responsible for:

- Observing and conforming to all relevant Australian Standards, all relevant Clean Energy Council Accreditation guidelines and all applicable laws, ordinances, regulations, codes of practice and local or national building codes, including any that may have superseded these Installation Instructions.
- Ensuring that the installation complies with AS/NZS 3000, AS/NZS 5033, AS/NZS 1170.2, AS/NZS 1562.1, AS 4777.1, AS/NZS 1768, AS/NZS 3008, AS 2050 and any relevant electrical service and installation rules for the state or territory where the system is installed.
- Ensuring that the PV System and associated components are appropriate for the particular installation and the installation environment.
- Ensure the system is integrated into any existing lightning protection system in accordance with the applicable local regulations.
- Ensuring that the roof, roof rafters, battens, purlins, connections, and other structural support members can support the total assembly under building live load conditions. The roof on which the PV system is to be installed must have the capacity to resist the combined Design Dead Load and Live Load at each mounting point.
- Ensuring only parts supplied by Solahart Industries and installer supplied parts as specified by Solahart Industries are utilised (substitution of parts may void the warranty and invalidate certification).
- Ensuring that lag screws have adequate pull-out strength and shear capacities to suit the installation.
- Maintaining the waterproof integrity of the roof, including selection of appropriate flashing.
- Ensuring safe installation of all electrical aspects of the PV system.

## DISCLAIMER OF LIABILITY AND WARRANTY

Solahart assumes no responsibility for loss, damage or expense resulting from improper installation, handling or misuse of PV modules. Refer to Solahart website [www.solahart.com.au](http://www.solahart.com.au) for full warranty terms and conditions.

## IEC 61730 INFORMATION

Modules supplied by Solahart are designed to fulfil the criteria of application Class A requirements according to IEC 61730. Modules are qualified for application Class A: Hazardous voltage (Higher than 50 V DC) and hazardous power (higher than 240 W) applications where general contact access is anticipated. For the purposes of AS/NZS 3000, modules are classified as Class I equipment.

## REQUIREMENTS FOR SYSTEM VOLTAGES GREATER THAN 600VDC

For installations where system voltages are greater than 600 V DC, ensure additional requirements outlined in AS/NZS 5033 are satisfied. These requirements include but are not limited to restricted access and protection of DC cabling. **Note:** AS/NZS 4777.1 does not permit installations with voltages greater than 600 V on domestic dwellings.

## FIRE GUIDELINES

Utilise the following fire safety guidelines when installing modules supplied by Solahart:

- Modules supplied by Solahart have a Class C Fire Rating.
- Check with local authorities for guidelines and requirements concerning fire safety for any building or structure on to which the modules will be installed.
- The system design should ensure that firefighting personnel can access the system in the event of a building fire. Check with local authorities for any applicable regulations concerning setbacks or other placement restrictions that may apply for roof-mounted PV arrays.
- Any electrical equipment can pose a fire risk. Modules must therefore be mounted over a fire retardant roof covering rated for the application and a sufficient distance between the module and the mounting surface must be maintained to allow free circulation of air beneath the module.

## ENVIRONMENTAL FACTORS

Solahart's limited warranty is based upon modules being installed in accordance with the following conditions:

- Modules are not suitable for installation in potentially hazardous locations.
- Modules shall not be installed in locations:
  - near sources of flammable gases, vapours or open flames.
  - in proximity to air conditioning systems.
  - in enclosed spaces (i.e. indoor), or on moving objects.
  - in direct contact with salt water/spray. Avoid installing in areas subject to high salt mist content.
  - which experience extreme hail and/or snow.
  - where they may be exposed to sulphur e.g. near sulphur springs or volcanoes
  - where they may be exposed to harmful chemicals.

## WARNINGS

**⚠Warning:** This document provides sufficient information for system installation heights up to 20 m. If the installation site is more than 20 m in height contact Solahart Industries for further advice.

**⚠Warning:** This system has not been certified for, and should not be installed in, wind region D.

**⚠Warning:** During installation and when working on the roof, be sure to observe the appropriate OH&S safety regulations and relevant regulations of your local region.

**⚠Warning:** Ensure electrical connection/ disconnection is performed only when the relevant circuit is isolated. Do not connect / disconnect wiring under load conditions.

**⚠Warning:** Do not expose the PV modules to artificially concentrated light.

**⚠Warning:** Do not drill holes in the modules as this will void product warranty.

# WIRING DIAGRAM

## SINGLE INPUT INVERTER SYSTEMS WITH SINGLE STRING – INTERNAL DC ISOLATOR

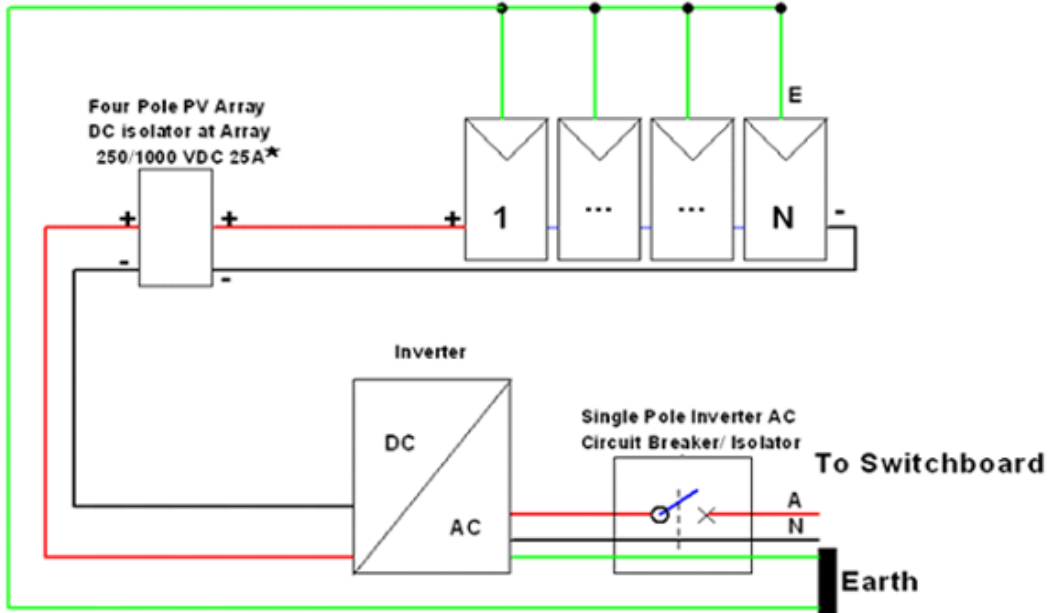

For DC Isolator Wiring refer to “DC Isolator Wiring” on page 41.

**Note:** The recommended circuit breaker rating for each inverter model is provided in the table below.

**Note:** Do not install additional external PV array DC Isolators adjacent to the inverter.

SOLAHART440BRB2 Modules								
Inverter	Min No of Modules	Max No of Modules per String***	Max No of Strings	Max No of Modules per Inverter	Max System Power Rating (W)*	AC Circuit Breaker Rating**	I <sub>sc</sub> (A)* per String	V <sub>oc</sub> (V)*
GW1500-XS-11	2	4	1	4	1760	10	14.10	Refer to Voltage Tables on page 11
GW2200-XS-11	2	6	1	6	2640	16		
GW2500-XS-11	2	7	1	7	3080	16		

**NOTE:** The above table is valid for flush mount installations only. For tilt-mount installations, please design the system as per the site location & requirements and include the bifacial gain from the rear side.

\* Values measured at standard test conditions (STC) defined as: irradiance of 1000 W/m<sup>2</sup>, Spectrum AM 1.5 and cell temperature 25°C. Variations from STC values will affect actual I<sub>sc</sub> and V<sub>oc</sub> and should be allowed for.

\*\*The current rating of the circuit breaker must be no greater than the current carrying capacity of the AC cable, refer to AS/NZS 3000.

\*\*\* 0°C is used to calculate maximum V. If minimum temperatures lower than 0°C are experienced at the installation site, maximum number of modules per String must be re-evaluated.

**MULTIPLE INPUT INVERTER SYSTEMS – INTERNAL DC ISOLATOR**

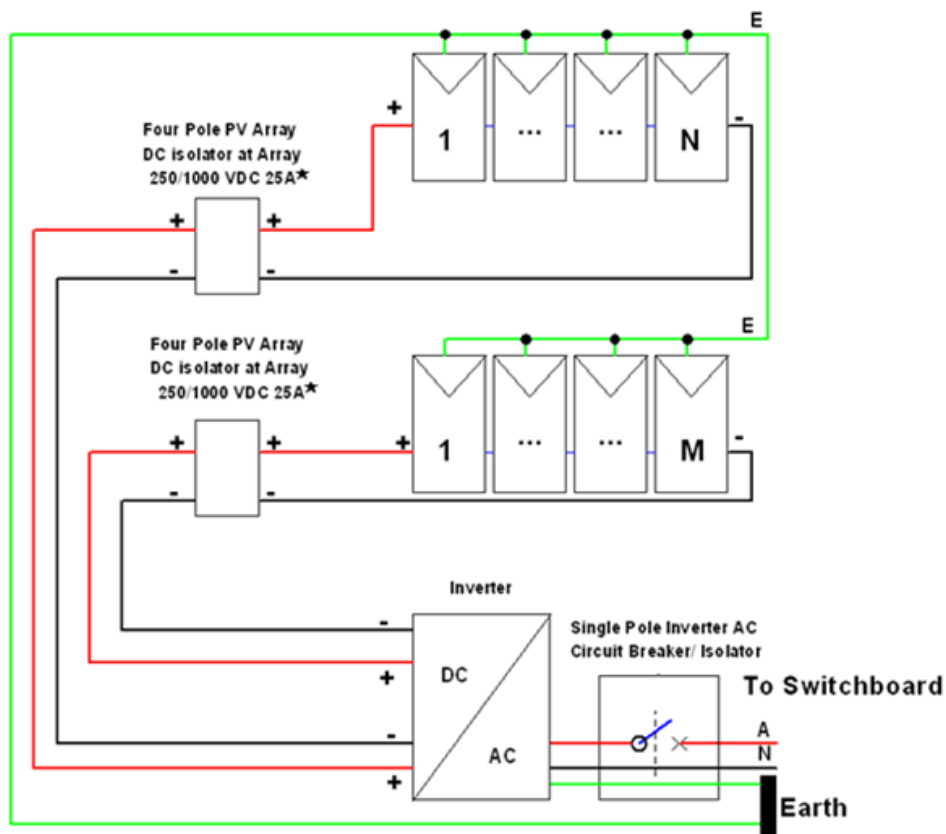

★For DC Isolator Wiring refer to “DC Isolator Wiring” on page 41.

**Note:** The recommended circuit breaker rating for each inverter model is provided in the table below.

**Note:** Do not install additional external PV array DC Isolators adjacent to the inverter.

SOLAHART440BRB2 Modules								
Inverter	Min No of Modules	Max No of Modules per String**	Max No of Strings per Input	Max No of Modules per Inverter	Max System Power Rating (W) *	AC Circuit Breaker Rating (A)***	I <sub>sc</sub> (A)* per String	V <sub>oc</sub> (V)*
GW3000-DNS-30	2	9	1/1	9	3960	25	14.10	Refer to Voltage Tables on page 11
GW5000-DNS-30	2	14	1/1	15	6600	32		
GW6000-DNS-30	2	14	1/1	18	7920	40		
GW5000-MS-30	2	14	1/1/1/1	15	6600	32		
GW8500-MS-30	2	14	1/1/1/1	25	11000	63		
UNO-DM-3.3-TL-SBQ	4	10	1/1	10	4400	25		
UNO-DM-4.0-TL-SBQ	4	12	1/1	12	5280	25		
UNO-DM-5.0-TL-SBQ	4	14	1/1	15	6600	32		
UNO-DM-6.0-TL-SBQ	4	14	1/1	18	7920	32		
GEH8.6-1U-10	3	14	1/1/1	26	11440	95		
GEH10-1U-10	3	14	1/1/1	30	13200	95		
GW5000N-EH	4	14	1/1	15	6600	50		
GW6000N-EH	4	14	1/1	19	7885	50		
GW5000-ES-20	3	14	1/1	15	6600	55		
GW6000-ES-20	3	14	1/1	18	7920	55		
GW10K-MS-30	3	14	1/1/1/1	30	13200	50		

**NOTE:** The above table is valid for flush mount installations only. For tilt-mount installations, please design the system as per the site location & requirements and include the bifacial gain from the rear side.

\* Values measured at standard test conditions (STC) defined as: irradiance of 1000 W/m<sup>2</sup>, Spectrum AM 1.5 and cell temperature 25°C. Variations from STC values will affect actual I<sub>sc</sub> and V<sub>oc</sub> and should be allowed for.

\*\* 0°C is used to calculate maximum V. If minimum temperatures lower than 0°C are experienced at the installation site, maximum number of modules must be re-evaluated.

\*\*\*The current rating of the circuit breaker must be no greater than the current carrying capacity of the AC cable, refer to AS/NZS 3000.

For earthing arrangement and wiring diagram refer to “Earthing Arrangements – All Systems” on page 13.



SE3000H, SE5000H AND SE6000H INVERTER SYSTEMS

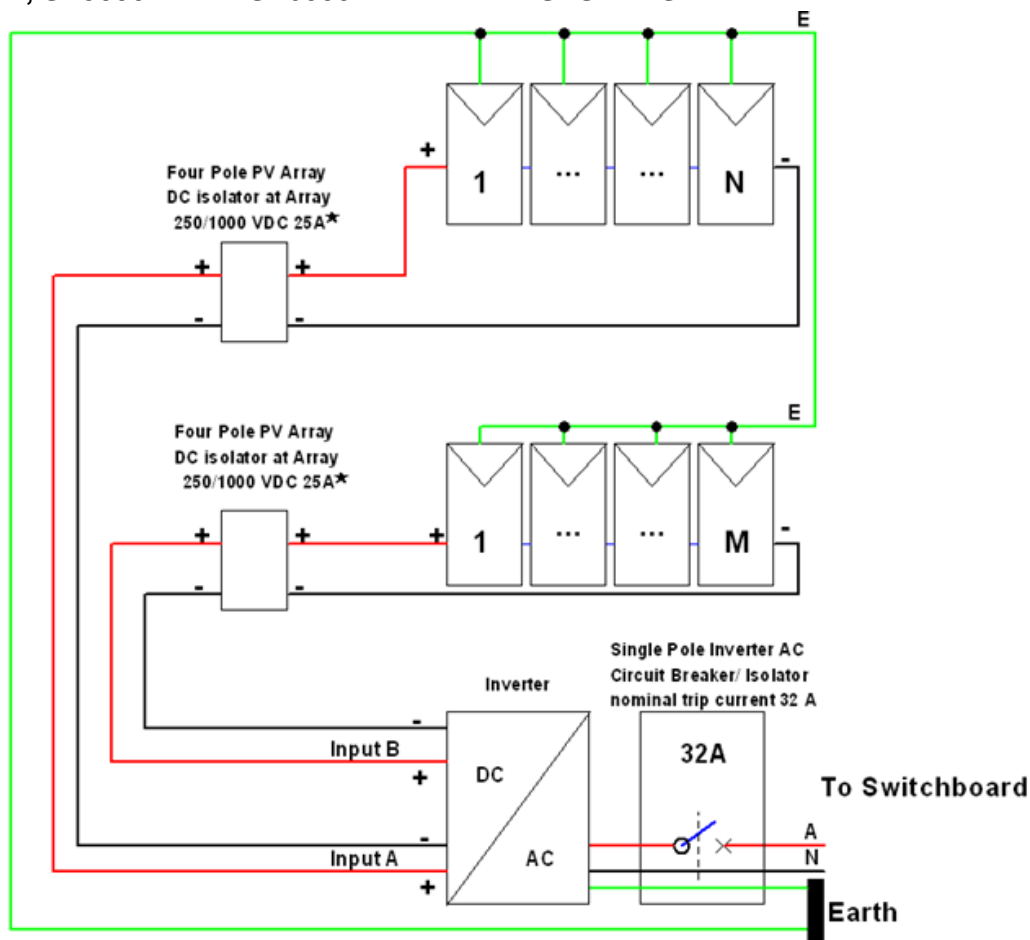

★ For DC Isolator Wiring refer to “DC Isolator Wiring” on page 41.

**Note:** Do not install additional external PV array DC Isolators adjacent to the inverter.

SOLAHART440BRB2 Modules									
Inverter	Min No of Modules		Max No of Modules per String	Max No of Strings	Max No of Modules per Inverter	Max System Power Rating (W) *	Max Inverter Input Current (A)*	Max Inverter Voltage (V)*	AC Circuit Breaker Size (A) ***
	S440	P505							
Optimiser	S440	P505							
SE3000H-xxxxxxxx**	8	6	9	1	9	3960	14	480	32
SE5000H-xxxxxxxx**	8	6	13	2	15	6600	23	480	32
SE6000H-xxxxxxxx**	8	6	13	2	18	7920	27.5	480	32

**NOTE:** The above table is valid for flush mount installations only. For tilt-mount installations, please design the system as per the site location & requirements and include the bifacial gain from the rear side.

\* Values measured at standard test conditions (STC) defined as: irradiance of 1000 W/m<sup>2</sup>, Spectrum AM 1.5 and cell temperature 25°C. Variations from STC values will affect actual I<sub>sc</sub> and V<sub>oc</sub> and should be allowed for.

\*\* This model may have suffixes indicating different options and functionality.

\*\*\*The current rating of the circuit breaker must be no greater than the current carrying capacity of the AC cable, refer to AS/NZS 3000.

For earthing arrangement and wiring diagram refer to “Earthing Arrangements – All Systems” on page 13.

## SE8250H AND SE10000H INVERTER SYSTEMS

**Note:** Ensure the single phase inverter limit, as set by your local electricity distributor, is larger than or equal to the inverter's rated AC power output as shown in the following table below.

SOLAHART440BRB2 Modules										
Inverter	Rated AC Power Output (W)	Max Number of DC Inputs	Number of Modules per String		Max Number of Strings	Max Number of Modules per Inverter	Max System Power Rating (W)*	Max Inverter Input Current (A)*	AC Circuit Breaker Size (A)***	
			Min	Max						
Optimiser			S440	P505						
SE8250H-xxxxxxxx**	8250	2	8	6	13	4	25	11000	37.5	50
SE10000H-xxxxxxxx**	10000	2	8	6	13	5	30	13200	45.5	50

**NOTE:** The above table is valid for flush mount installations only. For tilt-mount installations, please design the system as per the site location & requirements and include the bifacial gain from the rear side.

\* Values measured at standard test conditions (STC) defined as: irradiance of 1000 W/m<sup>2</sup>, Spectrum AM 1.5 and cell temperature 25°C. Variations from STC values will affect actual I<sub>sc</sub> and V<sub>oc</sub> and should be allowed for.

\*\* This model may have suffixes indicating different options and functionality.

\*\*\* The current rating of the circuit breaker must be no greater than the current carrying capacity of the AC cable, refer to AS/NZS 3000.

### STRING COMBINATION RULES FOR SE8250H and SE10000H

The following design rules must be followed:

1. The number of modules per string must satisfy the minimum and maximum requirements as indicated in the table above.
2. The number of strings per inverter must satisfy the maximum as indicated in the table above.
3. The maximum DC input limitations of the inverter are met.
4. Strings may be combined on the roof or at the ground.

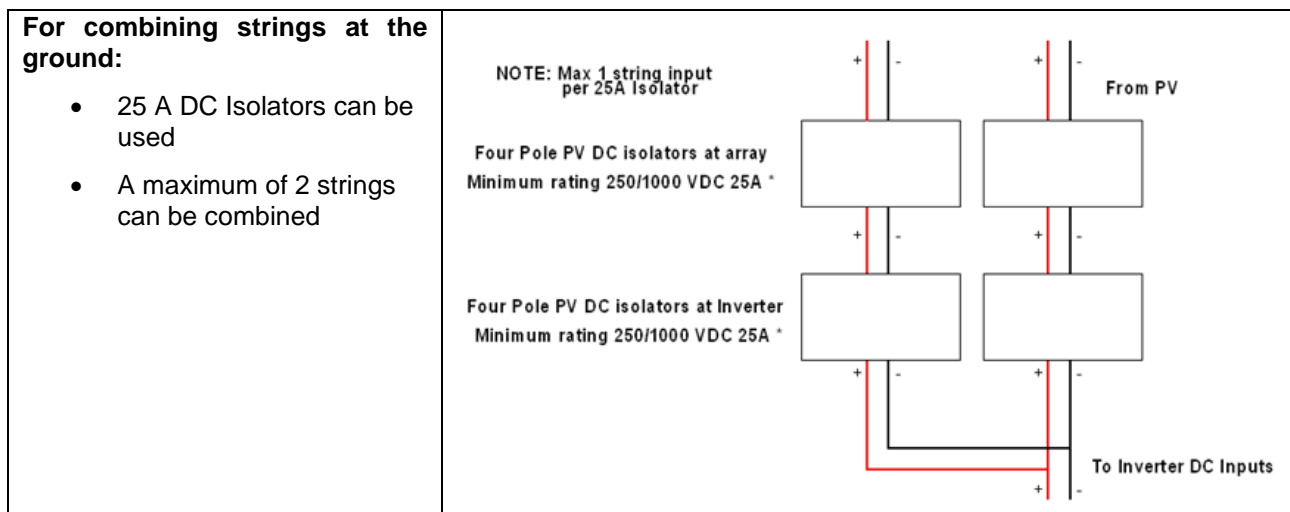

**For combining strings at the roof:**

- 55 A DC isolator must be used.
- A maximum of 3 strings can be combined per 55 A DC isolator.

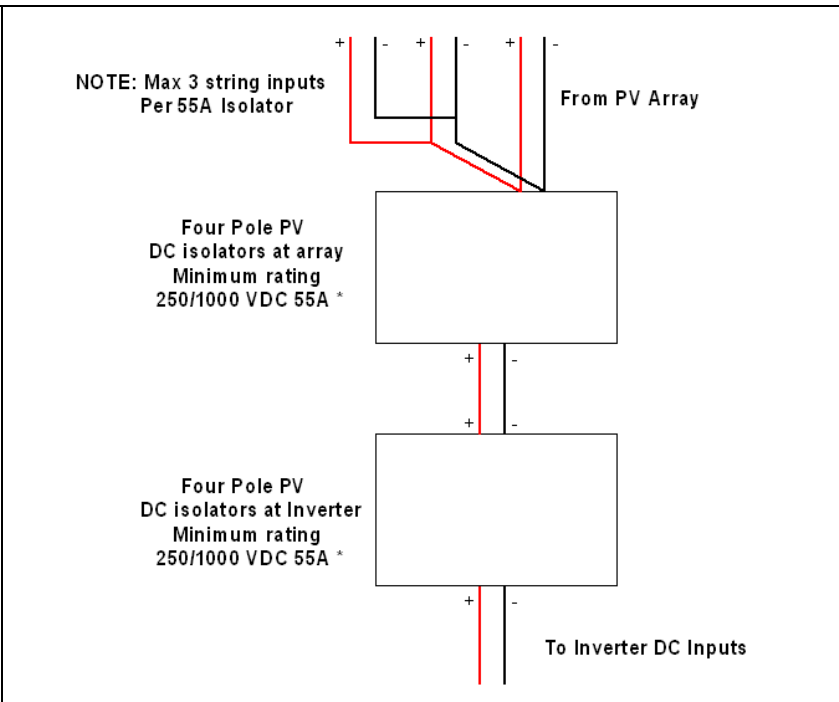

For earthing arrangement and wiring diagram refer to “Earthing Arrangements – All Systems” on page 13.

**VOLTAGE TABLES FOR FIMER AND GOODWE SYSTEMS**

SOLAHART440BRB2 (V <sub>oc</sub> = 39.00 V)			
No of Modules per String	V <sub>oc</sub> * of the String (V)	No of Modules per String	V <sub>oc</sub> * of the String (V)
3	117	14	546
4	156	15	585
5	195	16	624
6	234	17	663
7	273	18	702
8	312	19	741
9	351	20	780
10	390	21	819
11	429	22	858
12	468	23	897
13	507	24	936

\* Values measured at standard test conditions (STC) defined as: irradiance of 1000 W/m<sup>2</sup>, Spectrum AM 1.5 and cell temperature 25°C. Variations from STC values will affect actual V<sub>oc</sub> and should be allowed for.

**VOLTAGE TABLES FOR SOLAREEDGE SYSTEMS**

**Note:** SolarEdge Inverters operate on a fixed string voltage. The  $V_{oc}$  of the string is fixed to the nominal DC voltage of the inverter regardless of the panel  $V_{oc}$ .

Inverter Model	Nominal DC Voltage	$V_{oc}$ of string
SE5000H-xxxxxxxxx*	380 Vdc	380 Vdc
SE6000H-xxxxxxxxx*	380 Vdc	380 Vdc
SE8250H-xxxxxxxxx*	400 Vdc	400 Vdc
SE10000H-xxxxxxxxx*	400 Vdc	400 Vdc

\* This model may have suffixes indicating different options and functionality.

**DC ISOLATOR SIZING FOR SOLAREEDGE SYSTEMS**

As SolarEdge Systems have a constant  $V_{oc}$  for each string, and a variable  $I_{sc}$ , which is dependent on the number of modules per string, there are multiple DC isolator options which will work on its systems. It is vital to correctly size these DC Isolators to safely install and operate the PV system.

For each of the available DC Isolators follow this guide to correctly select the DC isolator required for the system.

**⚠ Warning:** Ensure string configuration is correct and compliant with the table below.

DC Isolator	Maximum allowable current	Maximum current per string	No of allowable Strings on each isolator
1000 V 25 A	17.6 A	15 A	1
1000 V 32 A	19.2 A	15 A	1
1000 V 55 A	40 A	15 A	3

## EARTHING ARRANGEMENTS – ALL SYSTEMS

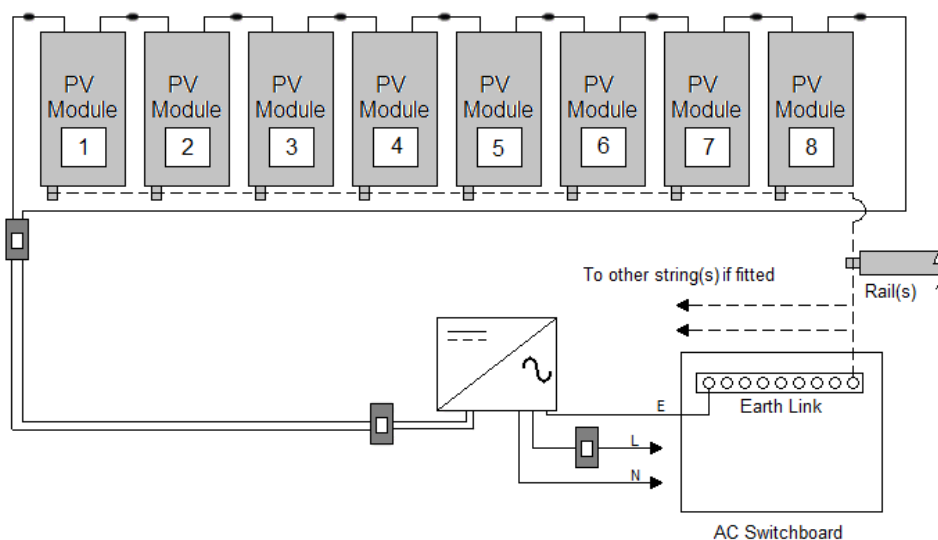

Earthing connections must be made so the removal of one component (e.g. a module) does not interrupt the earthing to other parts of a system (e.g. other modules). Daisy chaining is not permitted. The PV system earth connection must be directly connected to the switchboard earth link, not via the inverter earth connection. If the earth cable could be exposed to direct sunlight, it must have a physical barrier to protect the earth cable from this exposure.

Earth wires must be sized in accordance with requirements set out in Earthing and bonding arrangements of AS/NZS 5033.

Solahart approved Universal clamp with built-in earthing plates may be used to earth modules via the racking, instead of wiring directly to the module frames. Refer to “Earthing” on page 50 for more information.

**⚠ Warning:** Do not drill holes in the modules as this will void product warranty.

Where it is necessary to make an earthing connection to a rail, a Clenergy Earthing Lug may be used. In order to meet the minimum earthing electrical resistance requirement by AS/NZS 5033:2021, it is required to install one Grounding Lug per row of rail.

Follow the steps below to attach the earthing cable to Clenergy ECO rail.

1. Slide Z-module into the top channel on the ECO rail and tighten the M8\*25 bolt to 16~20 N.m.
2. Strip 20mm of earthing cable and insert the conductor into the provided copper tube.
3. Place the copper tube into the cable channel on the earthing lug and tighten the M6\*14 bolt to 5~6N.m. Pull the cable to ensure it is tight.
4. Check Resistance between rail and earthing cable conductor to ensure the bonding is made.

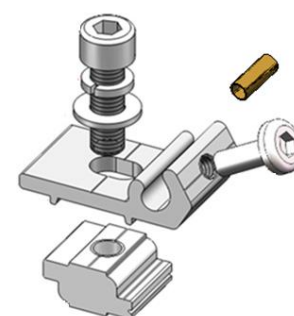

**Clenergy Earthing Lug**

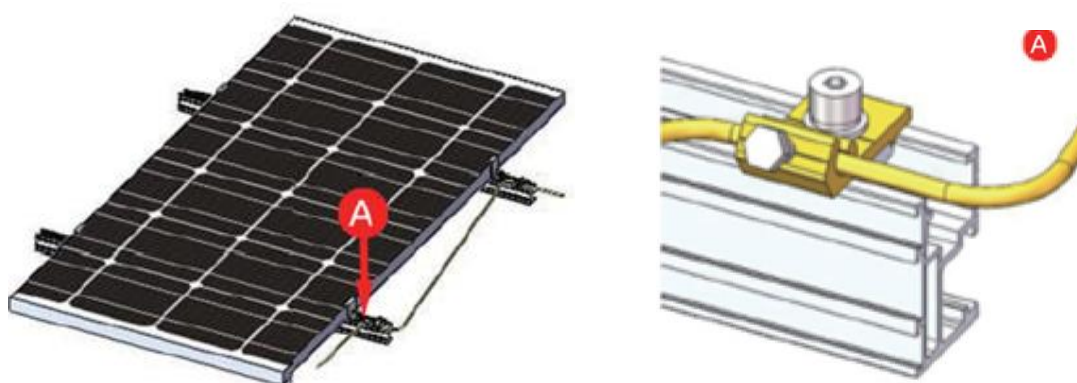

Note: the maximum earthing cable cross section area is 10mm<sup>2</sup>.

---

# INSTALLATION PROCEDURE

---

1. Planning – Design the system and layout. Refer to “Planning” on page 15.

Determine the spacing of the Rail Supports, using tables in section “Maximum Rail Support Spacing for Metal and Tile Roof” starting on page 30, and considering the following factors (refer to “Planning” on page 15):

- a. Wind Region
  - b. Terrain Category
  - c. Roof Type
  - d. Roof Pitch
  - e. Roof Area
  - f. Building Height
  - g. Array Orientation
2. Install the Racking (Rail and Rail Supports). Refer to “Racking” on page 21.
  3. Install the remainder of the roof top components as follows:
    - a. Rooftop Isolator. Refer to “Rooftop Isolator” on page 39.
    - b. Rooftop Wiring. Refer to “Wiring” on page 40.
    - c. Power Optimizers. Refer to “Power Optimisers (SolarEdge)” on page 42.
    - d. PV modules. Refer to “PV Modules” on page 49.
  4. Install the inverter. Refer to “Inverter” on page 54.
  5. Install the energy meter (optional component). Refer to “Meter (SolarEdge Only)” on page 57.
  6. Install the system labels. Refer to “Labelling” on page 58.
  7. Commission the PV system. Refer to “Commissioning” on page 62.

---

# PLANNING

---

## INSTALLATION TOOLS

- 4,5 & 6 mm Allen keys or 4,5 & 6 mm Allen Key fittings to suit torque adjustable drill (for racking components and inverter)
- Torx T20 screwdriver (FIMER inverter systems only)
- Cordless torque adjustable drill
- Angle grinder with stone disk (for tile cutting if required)
- Electricians hand tools (screwdrivers, pliers etc.)
- String line
- Timber to shim tile roof interfaces (if required)
- An Android or IOS smart device

## STRUCTURAL ASSESSMENT

The installer is responsible for ensuring that the building and building structures are capable of withstanding the additional loads and forces generated as a result of installing the PV system. For domestic dwellings, it is recommended that a structural engineering assessment is completed. For all other installations, a structural assessment is required to be completed by a qualified structural engineer.

**Note** – Please review the material of the roof for compatibility before quoting and installing. Solahart does not recommend installing a PV system on unpainted galvanised metal roofs.

## COMMUNICATIONS DEVICES

Complete installation of inverter communications devices requires the installer to register the communication device and inverter on the inverter manufacturer's web portal. Hence, to complete the communications equipment installation, the installer must have access to the PV system owner's internet connection. An example of items that should be organised prior to onsite installation are:

- Confirmation that an internet accessible network port is available
- Length of networking cable required from inverter to networking port
- Wi-Fi access including SSID and password
- PV system owner's network administrator permission and assistance to adjust firewall, network address translation (NAT) and port forwarding settings.

## PV MODULE ORIENTATION AND INCLINATION

To maximize system output, install modules at optimum orientation and inclination (tilt) angles. The specifics of this will depend on the installation location and must be calculated by a qualified system designer. The ideal angle for mounting a module should result in the sun's rays falling perpendicular (i.e. at a 90° angle) to the module surface.

**Note:** All modules in each series string must have the same orientation and inclination to ensure that modules do not underperform due to a mismatching of each module's output.

Modules should be installed in a shade free position. Even minor or partial shading of the modules/array will reduce array/system output. A module is considered shade free when it is both:

- Free from shade or shadows all year round.
- Exposed to several hours of direct sunlight, even during the shortest days of the year.
- Modules must have an inclination between 3° and 75°. If installed in tropical regions, the minimum module inclination angle is 5°.

**Note:** The following information is provided as a guide only:

- Modules should be installed facing toward true north. Where this orientation is not practical, a system facing up to 45° (NW or NE) from true north is satisfactory however losses of up to

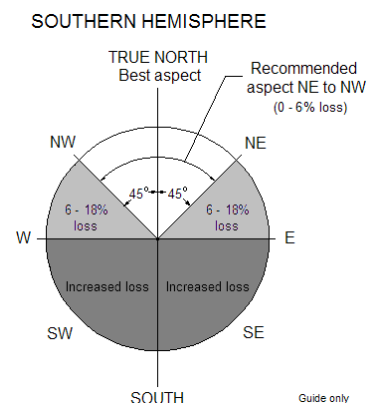

approximately 6% will occur. A module facing due east or due west will experience a loss in performance of approximately 18%.

- Inclination of modules should be approximately equal to the local latitude angle. The latitude of some Australian cities is shown in the “Latitude of Some Australian Cities” on page 16. Modules may be installed at the roof angle for simplicity of installation and appearance, however, if inclination varies by  $\pm 15^\circ$  or more from the correct inclination, performance losses of 4% or more will occur.
- Modules should be inclined at an angle of at least  $10^\circ$  to support the self-cleaning function of the glass.
- Losses for incorrect orientation and incorrect inclination will be compounded.
- If the roof angle is flat, adjustable or fixed tilt legs should be considered to optimise inclination depending upon area.
- For an installation at right angles to (across) a tile roof pitch, landscape tile roof hooks are required.
- Each module and its fittings including racking weighs approximately 25 kg.

**LATITUDE OF SOME AUSTRALIAN CITIES**

Adelaide	35°S	Cairns	17°S	Hobart	42°S	Port Hedland	20°S
Alice Springs	24°S	Canberra	35°S	Mildura	34°S	Rockhampton	24°S
Brisbane	27°S	Darwin	12°S	Melbourne	38°S	Sydney	34°S
Broken Hill	31°S	Geraldton	28°S	Perth	32°S	Townsville	19°S

**WIND REGION**

Use the wind region diagram shown below to determine the wind region of the installation site.

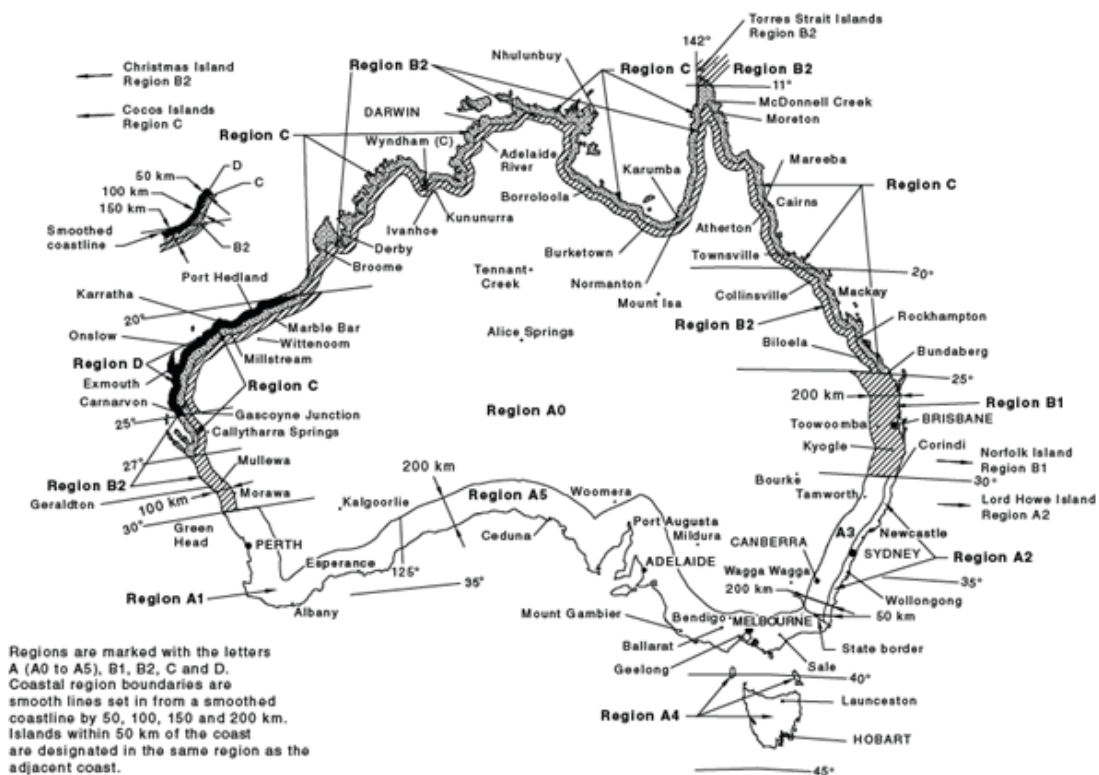

Wind region notes:

Wind regions are pre-defined for the whole of Australia by the Australian Standard 1170.2:2021.



## TERRAIN CATEGORY

Determine the terrain category to ensure the installation meets the maximum interface spacing specified in the engineering certificate.

**Terrain Category 1 (TC1)** – Very exposed open terrain with very few or no obstructions, and all water surfaces (e.g. flat, treeless, poorly grassed plains; open ocean, rivers, canals, bays and lakes).

**Terrain Category 2 (TC2)** – Open terrain, including grassland, with well-scattered obstructions having heights generally from 1.5m to 5m, with no more than two obstructions per hectare (e.g. farmland and cleared subdivisions with isolated trees and uncut grass).

**Terrain Category 2.5 (TC2.5)** – Terrain with some trees or isolated obstructions, terrain in developing outer urban areas with scattered houses, or larger acreage developments with more than two and less than 10 buildings per hectare.

**Terrain Category 3 (TC3)** – Terrain with numerous closely spaced obstructions having heights generally from 3 m to 10 m. The minimum density of obstructions shall be at least the equivalent of 10 house-size obstructions per hectare (e.g. suburban housing, light industrial estates or dense forests).

**Terrain Category 4 (TC4)** – Terrain with numerous large, high (10 m to 30 m tall) and closely spaced constructions, such as large city centres and well-developed industrial complexes.

## ATMOSPHERIC CORROSIVITY ZONE OF INSTALLATION SITE

Please refer to “AS 4312-2008 Atmospheric Corrosivity Zones in Australia” or consult local construction business to verify corrosivity category of installation site to determine appropriate products and interface spacing. When standard products are installed in high corrosivity zones, like C4/C5, interface spacing reduction factor need to be applied. Please refer to the generic notes of Clenergy Certification Letter for the details.

## ROOF TYPE

Determine the roof type of the building where the PV modules are to be installed and select the appropriate rail support.

Rail support systems are available as follows:

Roof Type	Roof Pitch	Rail Support Category	Rail Support Name (Options)
Standard tile	5 - 30°	Tile roof interface	Tile interface (Portrait)
Low profile tile			Tile interface (Landscape)
Slate			Flat tile interface
			Slate interface
Metal	5 - 30°	Metal roof interface	Metal roof interface
Metal Corrugated	< 10° or < Latitude minus 15°	Tilt leg interface	10 - 15° adjustable tilt legs

**Note:** For roof pitch more than 30°, consult Clenergy or Solahart for details on the design.

## ROOF AREA

There are 4 different roof zones for tilt leg installation: Internal Zone, Intermediate Zone, Edge Zone and Corner Zone. Please see diagrams and steps below to define area of each zone.

Step 1. Determine building height (h), width (b) and length (d)

Step 2. Check ratio of height to length/width (h/b and h/d)

If both h/b and h/d < 0.2, then a = 2h

Step 3. If h/b and h/d > 0.2 then a = the lowest value between 0.2b and 0.2d

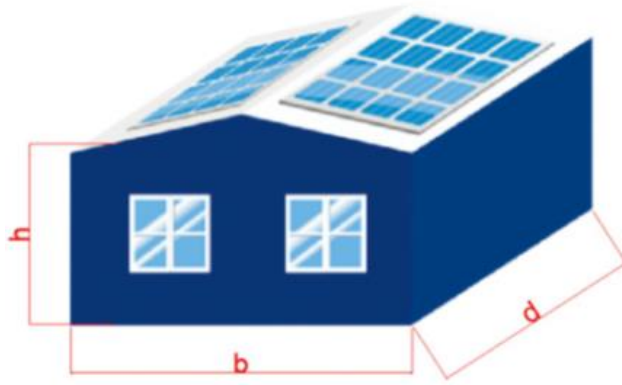

**⚠ Warning:** If any part of the system array is located in one of the edge zones, the entire array must use the support spacing specified for the edge zones.

**ROOF DEFINITION**

Roof Pitch < 10°

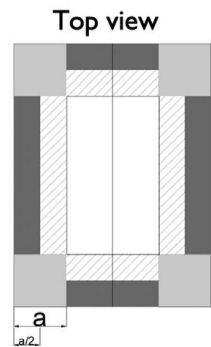
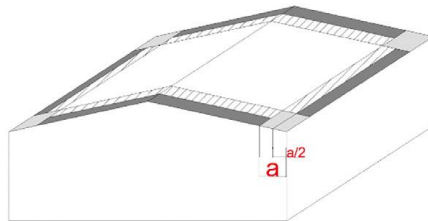
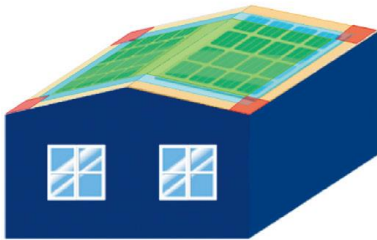

Flat/Mono – Slope Roof > 10°

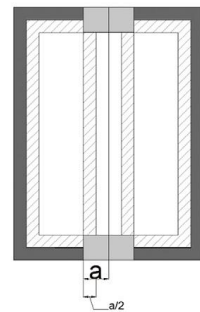
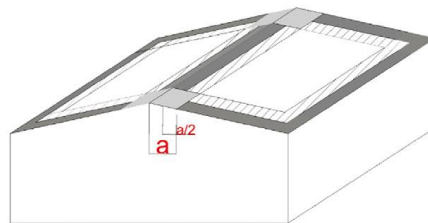
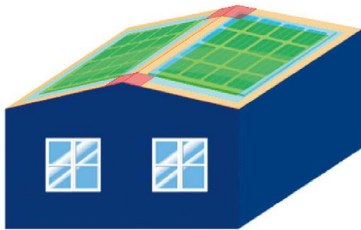



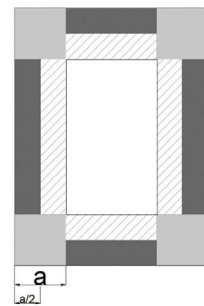
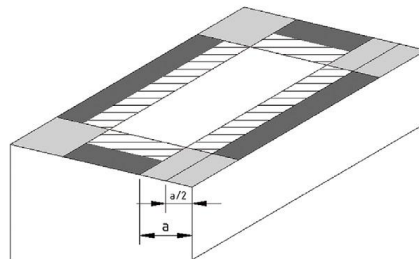
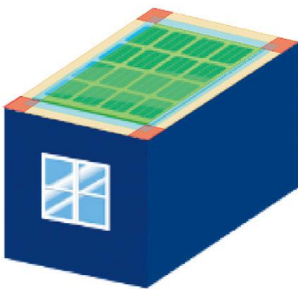

Flat/Mono – Slope Roof < 10°

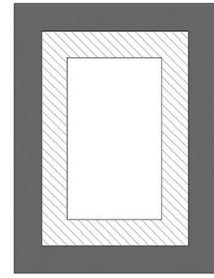
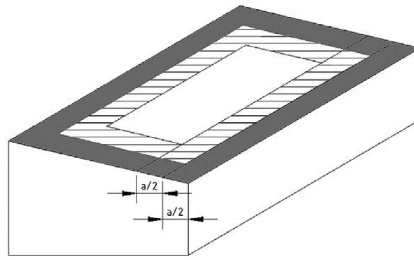

Flat/Mono – Slope Roof > 10°



-  Internal
-  Intermediate = "a/2"
-  Edge = "a/2"
-  Corner = "a/2"

**For further installation steps refer to the latest Clenergy Installation Guides on Clenergy website or Dealer portal.**

<https://www.solahart.com.au/dealers/pv-and-batteries/panels-racking/clenergy-racking/>

<https://www.clenergy.com.au/downloads/>

Use the following diagram, tables and worked example to determine the minimum required roof area for the array when designing and installing SOLAHART440BRB2 modules.

**Module spacing and dimensions**

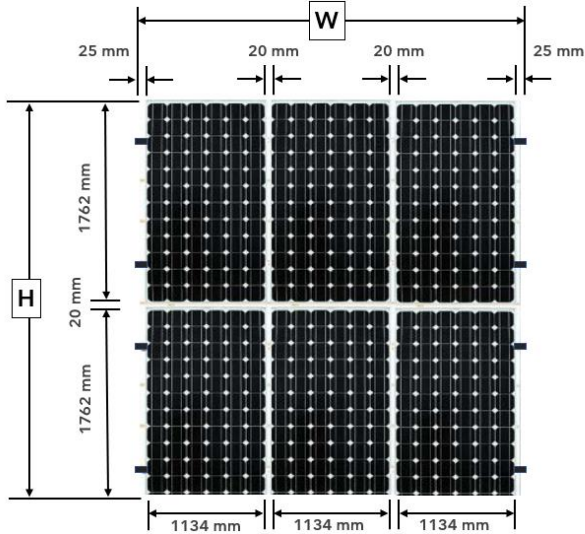

**H** = Number of rows x (1762 mm + 20 mm) - 20 mm

**W** = Number of modules per row x (1134 mm + 20 mm) + (2 x 25 mm) - 20 mm

**Worked Example:**

Number of rows: 2  
 Number of modules per row: 10  
 Total number of modules = 20

Calculating H:  
 $H = N_{\text{rows}} \times (1,762 + 20) - 20$   
 $H = 2 \times 1,782 - 20$   
 $H = 3,544 \text{ mm}$

Calculating W:  
 $W = N_{\text{modules/row}} \times (1,134 + 20) + (2 \times 25) - 20$   
 $W = 10 \times 1,154 + 50 - 20$   
 $W = 11,570 \text{ mm}$

Calculating Area<sub>Roof</sub> in mm<sup>2</sup>:  
 $\text{Area}_{\text{Roof}} = H \times W$   
 $\text{Area}_{\text{Roof}} = 3544 \times 11,570$   
 $\text{Area}_{\text{Roof}} = 41,004,080 \text{ mm}^2$

Converting Area<sub>Roof</sub> in mm<sup>2</sup> to m<sup>2</sup>:  
 $\text{Area}_{\text{Roof}} = \frac{41,004,080}{1,000,000} = 41.00 \text{ m}^2$

**Notes:**





- Modules installed in portrait as per diagram.
- For tilt leg systems, row spacing must prevent shading of one row by another and needs to be calculated on an individual site basis, taking into account orientation, roof pitch and module inclination.
- All dimensions are in mm, unless otherwise stated.



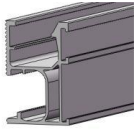
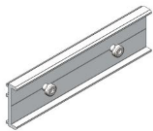

			Number of modules per row												
			1	2	3	4	5	6	7	8	9	10	...		
Number of rows	1	H	1762	1762	1762	1762	1762	1762	1762	1762	1762	1762	1762		
		X	X	X	X	X	X	X	X	X	X	X	X	X	
		W	1184	2338	3492	4646	5800	6954	8108	9262	10416	11570			
Number of rows	2	H	3544	3544	3544	3544	3544	3544	3544	3544	3544	3544	3544		
		X	X	X	X	X	X	X	X	X	X	X	X		
		W	1184	2338	3492	4646	5800	6954	8108	9262	10416	11570			
		⋮													

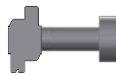

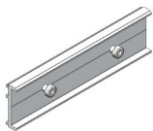

			Number of modules per row										
			1	2	3	4	5	6	7	8	9	10	...
Number of Rows	1	Area	2.08	4.12	6.15	8.18	10.22	12.25	14.29	16.32	18.35	20.39	
	2	Area	4.20	8.28	12.38	16.47	20.56	24.65	28.73	32.82	36.91	41.00	
		⋮											

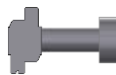
# RACKING

## OVERVIEW OF RACKING COMPONENTS

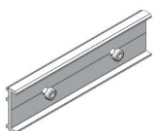
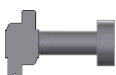
Overview of components for tile roof				
				
Rail (a)	Rail splices (c)	Tile roof Interfaces (b)	Z-modules with Allen head bolt	Wood screws M6 x 80

Overview of components for metal roof				
				
Rail (a)	Rail splices (c)	Metal roof interfaces (b)	Z-modules with Allen head bolt	Wood screws M6 x 90 *

Overview of components for adjustable tilt legs					
					
Rail (a)	Rail splices (c)	Z-modules with Allen head bolt	Front rail & leg foot (d)	Adjustable tilt leg (e)	Wood Screws M6x90 *

\* **Note:** Screws must be fit for purpose e.g. screws used in metal purlins must be suitable for metal structures and have a TPI (threads per inch) of 14.

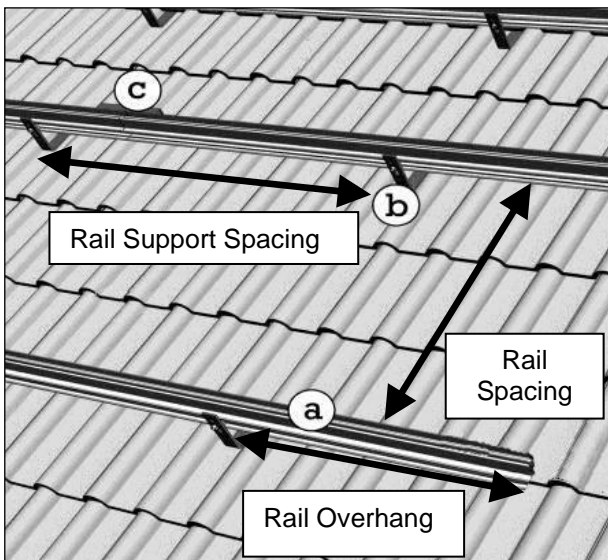

Tile & Metal Roof Diagram (Tile Roof shown)

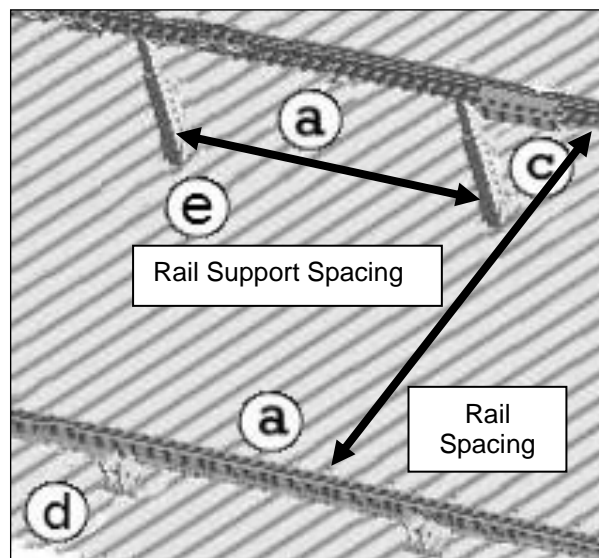

Tilt Leg Diagram (Adjustable Tilt Leg shown)

## MAXIMUM RAIL SUPPORT SPACING FOR METAL AND TILE ROOFS

**STEP-1** Have all the details and calculations for wind region, terrain category, roof pitch, roof position area (Edge Zone or Centre Zone) and maximum height of the installation. You should have the **h/d** and **h/b** ratios of the installation site, where h= height, b= width and d= length of the building.

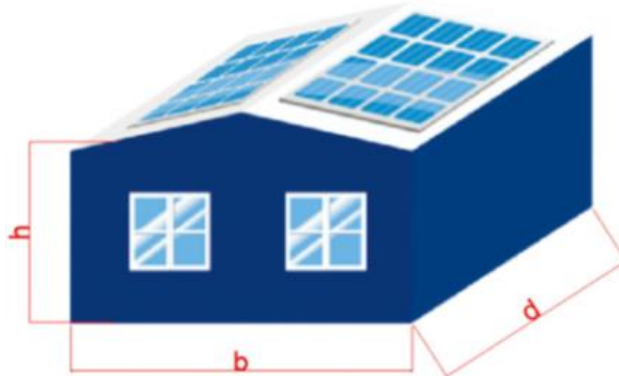

**NOTE:** Detailed information on this is in the Clenergy installation manuals.

**STEP-2** Select the type of rail you plan to install – ECO or ELITE rail. Use the below information to select the right table for your installation.

**STEP-3** Select the right table for your installation with ECO rails.

**For ECO Rails: (ER-R-ECO-3600, ER-R-ECO-3600/BA, ER-R-ECO-4400 and ER-R-ECO-4400/BA)**

- For **ECO** rail on **tile roof** (using ER-I-01/ ER-01-PK28) flush mount installation use **TABLE-1**
- For **ECO** rail on **tin roof** (using ER-I-05/ PV-05-PK50) flush mount installation use **TABLE-2**
- For **ECO** rail on **tin roof using tilt-legs** for tilt mount installation use **TABLE-5**
- If you are using any other interface or accessory, then please work out the spacing tables using the relevant factors provided in the relevant Clenergy General Certificate.

**For ELITE Rails: (ER-R-ELT-3600/MF, ER-R-ELT-3600/BA, ER-R-ELT-4400/MF and ER-R-ELT-4400/BA)**  
**Please be aware the torque settings are different for ELITE Rails installation. Please refer to the Clenergy installation manual for complete details**

- For **ELITE** rail on **tile roof** (using ER-I-01/ ER-01-PK28) flush mount installation use **TABLE-1**
- For **ELITE** rail (**Building h/d and h/b ratio  $\leq 0.5$** ) on **tin roof** (using ER-I-05/ PV-05-PK50) flush mount installation use **TABLE-3**
- For **ELITE** rail (**Building h/d and h/b ratio  $> 0.5$** ) on **tin roof** (using ER-I-05/ PV-05-PK50) flush mount installation use **TABLE-4**
- For **ELITE** rail on **tin roof using tilt-legs** for tilt mount installation use **TABLE-4**
- If you are using any other interface or accessory, then please work out the spacing tables using the relevant factors provided in the relevant Clenergy General Certificate.

Use the following tables to determine the maximum rail support spacing for the relevant roof type based on the previously determined wind region, terrain category, roof pitch, roof position area (Edge Zone or Centre Zone) and maximum height of the installation. The maximum spacing values below are in mm.

- ⚠ **Warning:** The following tables cover the only installations permitted for SOLAHART440BRB2 modules based on mechanical design load of 3600/1600 Pa.
- ⚠ **Warning:** These tables are only when using the standard tin and tile hooks ER-I-01 and ER-I-05. Reduction factors for other interfaces are provided in the Clenergy Installation manual and the General Certificate document.
- ⚠ **Warning:** Installation is prohibited if the spacing is **N/A**.

**TABLE-1** TILE INTERFACE SPACING FOR ECO (ER-R-ECO & ER-I-01) & ELITE RAIL (ER-R-ELT & ER-I-01)  
SOLAR PANEL SIZE 1762 x 1134 x 30 mm

## TILE INTERFACE SPACING TABLES FOR SOLAHART SILHOUETTE PANELS

ROOF ANGLE	0° < α ≤ 10°									
TC	3									
BUILDING HEIGHT (m)	≤ 5		5<H≤10		10<H≤15		15<H≤20		20<H≤30	
	UW&DW	Central	UW&DW	Central	UW&DW	Central	UW&DW	Central	UW&DW	Central
A	1736	1909	1684	1852	1597	1757	1580	1738	1528	1681
B1	1510	1661	1276	1404	1163	1279	1068	1186	993	1092
B2	1072	1179	982	1081	857	943	743	817	697	766
C	1018	1120	836	919	N/A	835	N/A	779	N/A	728

ROOF ANGLE	0° < α ≤ 10°									
TC	2.5									
BUILDING HEIGHT (m)	≤ 5		5<H≤10		10<H≤15		15<H≤20		20<H≤30	
	UW&DW	Central	UW&DW	Central	UW&DW	Central	UW&DW	Central	UW&DW	Central
A	1632	1795	1583	1741	1502	1652	1485	1634	1436	1580
B1	1420	1562	1199	1320	1093	1203	1005	1115	934	1026
B2	1008	1109	923	1015	806	887	699	768	655	720
C	N/A	1053	N/A	865	N/A	784	N/A	732	N/A	685

ROOF ANGLE	0° < α ≤ 10°									
TC	2									
BUILDING HEIGHT (m)	≤ 5		5<H≤10		10<H≤15		15<H≤20		20<H≤30	
	UW&DW	Central	UW&DW	Central	UW&DW	Central	UW&DW	Central	UW&DW	Central
A	1548	1702	1502	1652	1424	1566	1409	1550	1362	1499
B1	1347	1481	1138	1251	1037	1141	N/A	1058	N/A	974
B2	956	1051	876	964	N/A	841	N/A	729	N/A	684
C	N/A	998	N/A	820	N/A	N/A	N/A	N/A	N/A	N/A

ROOF ANGLE	10° < α ≤ 20°									
TC	3									
BUILDING HEIGHT (m)	≤ 5		5<H≤10		10<H≤15		15<H≤20		20<H≤30	
	UW&DW	Central	UW&DW	Central	UW&DW	Central	UW&DW	Central	UW&DW	Central
A	1700	1870	1649	1814	1564	1720	1548	1701	1496	1645
B1	1479	1627	1249	1375	1139	1253	1046	1161	972	1070
B2	1050	1155	962	1058	840	923	728	800	683	750
C	997	1097	819	901	N/A	817	N/A	763	N/A	713

ROOF ANGLE	10° < α ≤ 20°									
TC	2.5									
BUILDING HEIGHT (m)	≤ 5		5<H≤10		10<H≤15		15<H≤20		20<H≤30	
	UW&DW	Central	UW&DW	Central	UW&DW	Central	UW&DW	Central	UW&DW	Central
A	1592	1751	1544	1698	1464	1611	1449	1593	1401	1541
B1	1385	1524	1170	1288	1067	1173	980	1088	911	1002
B2	982	1081	901	991	786	865	682	749	N/A	703
C	N/A	1027	N/A	843	N/A	765	N/A	715	N/A	N/A

RACKING

ROOF ANGLE	10° < α ≤ 20°									
TC	2									
BUILDING HEIGHT (m)	≤ 5		5<H≤10		10<H≤15		15<H≤20		20<H≤30	
	UW&DW	Central	UW&DW	Central	UW&DW	Central	UW&DW	Central	UW&DW	Central
A	1520	1672	1475	1621	1399	1538	1383	1522	1337	1472
B1	1323	1455	1117	1229	1018	1120	N/A	1038	N/A	957
B2	938	1033	860	946	N/A	826	N/A	716	N/A	671
C	N/A	980	N/A	805	N/A	N/A	N/A	N/A	N/A	N/A

ROOF ANGLE	20° < α ≤ 30°									
TC	3									
BUILDING HEIGHT (m)	≤ 5		5<H≤10		10<H≤15		15<H≤20		20<H≤30	
	UW&DW	Central	UW&DW	Central	UW&DW	Central	UW&DW	Central	UW&DW	Central
A	1680	1848	1630	1793	1545	1700	1529	1682	1479	1627
B1	1461	1608	1234	1358	1125	1239	1034	1147	961	1057
B2	1037	1141	950	1045	829	913	719	791	674	742
C	985	1084	809	890	N/A	808	N/A	754	N/A	704

ROOF ANGLE	20° < α ≤ 30°									
TC	2.5									
BUILDING HEIGHT (m)	≤ 5		5<H≤10		10<H≤15		15<H≤20		20<H≤30	
	UW&DW	Central	UW&DW	Central	UW&DW	Central	UW&DW	Central	UW&DW	Central
A	1576	1734	1529	1682	1450	1595	1434	1578	1387	1526
B1	1371	1508	1159	1274	1056	1162	969	1076	902	991
B2	973	1070	891	981	778	856	674	742	N/A	696
C	N/A	1017	N/A	835	N/A	758	N/A	N/A	N/A	N/A

ROOF ANGLE	20° < α ≤ 30°									
TC	2									
BUILDING HEIGHT (m)	≤ 5		5<H≤10		10<H≤15		15<H≤20		20<H≤30	
	UW&DW	Central	UW&DW	Central	UW&DW	Central	UW&DW	Central	UW&DW	Central
A	1504	1655	1459	1605	1383	1523	1369	1506	1324	1456
B1	1308	1439	1106	1216	1008	1109	N/A	1028	N/A	946
B2	929	1021	851	936	743	817	N/A	708	N/A	663
C	N/A	970	N/A	796	N/A	N/A	N/A	N/A	N/A	N/A

**TABLE-2 TIN INTERFACE SPACING FOR ECO (ER-R-ECO & ER-I-05)**  
**SOLAR PANEL SIZE 1762 x 1134 x 30 mm**

TIN INTERFACE SPACING TABLES FOR SOLAHART SILHOUETTE PANELS

ANGLE TO THE HORIZONTAL	0° < α ≤ 10°									
TC	3									
BUILDING HEIGHT (m)	< 5		5<H≤10		10<H≤15		15<H≤20		20<H≤30	
	UW&DW	Central	UW&DW	Central	UW&DW	Central	UW&DW	Central	UW&DW	Central
A	2007	2197	2007	2197	1907	2084	1834	2000	1753	1910
B1	1749	1984	1749	1984	1664	1886	1602	1813	1533	1734
B2	1738	1970	1738	1970	1654	1873	1592	1801	1525	1723
C	1554	1756	1554	1756	N/A	1671	N/A	1608	N/A	1540

ANGLE TO THE HORIZONTAL	0° < α ≤ 10°									
TC	2.5									
BUILDING HEIGHT (m)	< 5		5<H≤10		10<H≤15		15<H≤20		20<H≤30	
	UW&DW	Central	UW&DW	Central	UW&DW	Central	UW&DW	Central	UW&DW	Central
A	1940	2120	1869	2041	1792	1954	1741	1896	1683	1830
B1	1691	1917	1632	1848	1566	1772	1523	1721	1473	1663
B2	1681	1904	1622	1835	1558	1760	1514	1711	1445	1653
C	N/A	1698	N/A	1639	N/A	1573	N/A	1529	N/A	1479

ANGLE TO THE HORIZONTAL	0° < α ≤ 10°									
TC	2									
BUILDING HEIGHT (m)	< 5		5<H≤10		10<H≤15		15<H≤20		20<H≤30	
	UW&DW	Central	UW&DW	Central	UW&DW	Central	UW&DW	Central	UW&DW	Central
A	1877	2049	1753	1910	1693	1843	1660	1805	1618	1758
B1	1638	1855	1533	1734	1482	1674	N/A	1641	N/A	1600
B2	1629	1843	1525	1723	N/A	1665	N/A	1632	N/A	1591
C	N/A	1646	N/A	1540	N/A	N/A	N/A	N/A	N/A	N/A



ANGLE TO THE HORIZONTAL	$10^\circ < \alpha \leq 20^\circ$									
TC	3									
BUILDING HEIGHT (m)	< 5		5<H≤10		10<H≤15		15<H≤20		20<H≤30	
	UW&DW	Central	UW&DW	Central	UW&DW	Central	UW&DW	Central	UW&DW	Central
A	2007	2289	2007	2289	1907	2170	1834	2083	1753	1990
B1	1749	1984	1749	1984	1664	1886	1602	1813	1533	1734
B2	1738	1970	1738	1970	1654	1873	1592	1801	1525	1723
C	1554	1756	1554	1756	N/A	1671	N/A	1608	N/A	1540

ANGLE TO THE HORIZONTAL	$10^\circ < \alpha \leq 20^\circ$									
TC	2.5									
BUILDING HEIGHT (m)	< 5		5<H≤10		10<H≤15		15<H≤20		20<H≤30	
	UW&DW	Central	UW&DW	Central	UW&DW	Central	UW&DW	Central	UW&DW	Central
A	1940	2208	1869	2126	1792	2035	1741	1975	1683	1906
B1	1691	1917	1632	1848	1566	1772	1523	1721	1473	1663
B2	1681	1904	1622	1835	1558	1760	1514	1711	1445	1653
C	N/A	1698	N/A	1639	N/A	1573	N/A	1529	N/A	1479

ANGLE TO THE HORIZONTAL	$10^\circ < \alpha \leq 20^\circ$									
TC	2									
BUILDING HEIGHT (m)	< 5		5<H≤10		10<H≤15		15<H≤20		20<H≤30	
	UW&DW	Central	UW&DW	Central	UW&DW	Central	UW&DW	Central	UW&DW	Central
A	1877	2134	1753	1990	1693	1920	1660	1880	1618	1831
B1	1638	1855	1533	1734	1482	1674	N/A	1641	N/A	1600
B2	1629	1843	1525	1723	N/A	1665	N/A	1632	N/A	1591
C	N/A	1646	N/A	1540	N/A	N/A	N/A	N/A	N/A	N/A

ANGLE TO THE HORIZONTAL	$20^\circ < \alpha \leq 30^\circ$									
TC	3									
BUILDING HEIGHT (m)	< 5		5<H≤10		10<H≤15		15<H≤20		20<H≤30	
	UW&DW	Central	UW&DW	Central	UW&DW	Central	UW&DW	Central	UW&DW	Central
A	2007	2289	2007	2289	1907	2170	1834	2083	1753	1990
B1	1749	1984	1749	1984	1664	1886	1602	1813	1533	1734
B2	1738	1970	1738	1970	1654	1873	1592	1801	1525	1723
C	1554	1756	1554	1756	N/A	1671	N/A	1608	N/A	1540

**TABLE-3 TIN INTERFACE SPACING FOR ELITE RAIL (ER-I-05 & ER-R-ELT)**  
**SOLAR PANEL SIZE 1762 x 1134 x 30 mm**

**NOTE:** Use these tables when  $h/d \leq 0.5$  and  $h/b \leq 0.5$ . Where  $h$ = height,  $b$ = width and  $d$ = length of the building.

Angle	$0^\circ < \alpha \leq 30^\circ$									
TC	3									
Building Height (m)	$\leq 5$		$5 < H \leq 10$		$10 < H \leq 15$		$15 < H \leq 20$		$20 < H \leq 30$	
	UW & DW	Central	UW & DW	Central	UW & DW	Central	UW & DW	Central	UW & DW	Central
A	1576	1877	1565	1820	1560	1820	1484	1543	1420	1474
B1	1472	1552	1368	1552	1401	1527	1348	1467	1198	1404
B2	1463	1540	1359	1540	1393	1515	1340	1457	1192	1394
C	1324	1497	1324	1497	N/A	1424	N/A	1371	N/A	1313

Angle	$0^\circ < \alpha \leq 30^\circ$									
TC	2.5									
Building Height (m)	$\leq 5$		$5 < H \leq 10$		$10 < H \leq 15$		$15 < H \leq 20$		$20 < H \leq 30$	
	UW & DW	Central	UW & DW	Central	UW & DW	Central	UW & DW	Central	UW & DW	Central
A	1570	1872	1533	1768	1452	1612	1410	1463	1362	1412
B1	1424	1499	1276	1445	1319	1434	1281	1394	1150	1347
B2	1415	1488	1268	1435	1311	1425	1274	1386	N/A	1339
C	N/A	1448	N/A	1396	N/A	1341	N/A	N/A	N/A	N/A

Angle	$0^\circ < \alpha \leq 30^\circ$									
TC	2									
Building Height (m)	$\leq 5$		$5 < H \leq 10$		$10 < H \leq 15$		$15 < H \leq 20$		$20 < H \leq 30$	
	UW & DW	Central	UW & DW	Central	UW & DW	Central	UW & DW	Central	UW & DW	Central
A	1519	1768	1437	1539	1372	1423	1344	1394	1310	1357
B1	1379	1450	1198	1356	1247	1355	N/A	1329	N/A	1295
B2	1371	1441	1192	1347	N/A	1348	N/A	1321	N/A	1288
C	N/A	1402	N/A	1313	N/A	N/A	N/A	N/A	N/A	N/A

**TABLE-4 TIN INTERFACE (ER-I-05) AND TILT LEG SPACING FOR ELITE RAIL (ER-R-ELT)  
SOLAR PANEL SIZE 1762 x 1134 x 30 mm**

Please design the system for tilt legs, as per site conditions and considering the bifacial gain from the rear side

**NOTE:** - For flush mount installations, use these tables when h/b or h/d is > 0.5. Where h= height, b= width and d= length of the building.

Use the following tables to determine the maximum rail support spacing for the relevant roof type based on the previously determined wind region, terrain category, roof pitch, roof position area (Corner Zone, Edge Zone, Intermediate Zone or Internal Zone) and maximum height of the installation. **The spacing values below are in mm.**

⚠ **Warning:** the following tables cover the only installations permitted for SOLAHART440BRB2 modules based on mechanical design load of 3600/1600 Pa.

⚠ **Warning:** Installation is prohibited if the spacing is N/A.

Angle	0° < α ≤ 5°																			
TC	3																			
Building Height (m)	< 5				5<H≤10				10<H≤15				15<H≤20				20<H≤30			
	Internal	Intermediate	Edge	Corner	Internal	Intermediate	Edge	Corner	Internal	Intermediate	Edge	Corner	Internal	Intermediate	Edge	Corner	Internal	Intermediate	Edge	Corner
A	2019	1882	1716	N/A	2019	1872	1768	N/A	1910	1768	1768	N/A	1831	1589	N/A	N/A	1746	1519	N/A	N/A
B1	1777	1531	1417	N/A	1777	1531	1417	N/A	1688	1456	N/A	N/A	1621	1400	N/A	N/A	1549	N/A	N/A	N/A
B2	1764	1520	N/A	N/A	1764	1520	N/A	N/A	1675	1447	N/A	N/A	1610	N/A	N/A	N/A	1538	N/A	N/A	N/A
C	1121	N/A	N/A	N/A	1121	N/A	N/A	N/A	914	N/A	N/A	N/A	878	N/A	N/A	N/A	N/A	N/A	N/A	N/A

Angle	0° < α ≤ 5°																			
TC	2.5																			
Building Height (m)	< 5				5<H≤10				10<H≤15				15<H≤20				20<H≤30			
	Internal	Intermediate	Edge	Corner	Internal	Intermediate	Edge	Corner	Internal	Intermediate	Edge	Corner	Internal	Intermediate	Edge	Corner	Internal	Intermediate	Edge	Corner
A	1945	1683	1664	N/A	1924	1768	N/A	N/A	1872	1716	N/A	N/A	1733	1508	N/A	N/A	1671	N/A	N/A	N/A
B1	1716	1480	N/A	N/A	1653	1428	N/A	N/A	1584	1370	N/A	N/A	1538	N/A	N/A	N/A	1485	N/A	N/A	N/A
B2	1703	1470	N/A	N/A	1641	1419	N/A	N/A	1573	N/A	N/A	N/A	1528	N/A	N/A	N/A	1475	N/A	N/A	N/A
C	1083	N/A	N/A	N/A	1045	N/A	N/A	N/A	N/A	N/A	N/A	N/A	N/A	N/A	N/A	N/A	N/A	N/A	N/A	N/A

Angle	0° < α ≤ 5°																			
TC	2																			
Building Height (m)	< 5				5<H≤10				10<H≤15				15<H≤20				20<H≤30			
	Internal	Intermediate	Edge	Corner	Internal	Intermediate	Edge	Corner	Internal	Intermediate	Edge	Corner	Internal	Intermediate	Edge	Corner	Internal	Intermediate	Edge	Corner
A	1877	1627	N/A	N/A	1746	1519	N/A	N/A	1683	N/A	N/A	N/A	1648	N/A	N/A	N/A	1605	N/A	N/A	N/A
B1	1660	1433	N/A	N/A	1549	N/A	N/A	N/A	1495	N/A	N/A	N/A	1466	N/A	N/A	N/A	1428	N/A	N/A	N/A
B2	1647	1424	N/A	N/A	1538	N/A	N/A	N/A	1486	N/A	N/A	N/A	1457	N/A	N/A	N/A	1419	N/A	N/A	N/A
C	1049	N/A	N/A	N/A	N/A	N/A	N/A	N/A	N/A	N/A	N/A	N/A	N/A	N/A	N/A	N/A	N/A	N/A	N/A	N/A

Angle	5° < α < 10°																			
TC	3																			
Building Height (m)	< 5				5<H≤10				10<H≤15				15<H≤20				20<H≤30			
	Internal	Intermediate	Edge	Corner	Internal	Intermediate	Edge	Corner	Internal	Intermediate	Edge	Corner	Internal	Intermediate	Edge	Corner	Internal	Intermediate	Edge	Corner
A	2019	1743	1617	N/A	2019	1743	1617	N/A	1910	1654	1537	N/A	1831	1589	N/A	N/A	1746	1519	N/A	N/A
B1	1777	1531	1417	N/A	1777	1531	1417	N/A	1688	1456	N/A	N/A	1621	1400	N/A	N/A	1549	N/A	N/A	N/A
B2	1764	1520	N/A	N/A	1764	1520	N/A	N/A	1675	1447	N/A	N/A	1610	N/A	N/A	N/A	1538	N/A	N/A	N/A
C	1121	N/A	N/A	N/A	1121	N/A	N/A	N/A	914	N/A	N/A	N/A	878	N/A	N/A	N/A	N/A	N/A	N/A	N/A

Angle	5° < α < 10°																			
TC	2.5																			
Building Height (m)	< 5				5<H≤10				10<H≤15				15<H≤20				20<H≤30			
	Internal	Intermediate	Edge	Corner	Internal	Intermediate	Edge	Corner	Internal	Intermediate	Edge	Corner	Internal	Intermediate	Edge	Corner	Internal	Intermediate	Edge	Corner
A	1945	1683	1563	N/A	1869	1621	N/A	N/A	1787	1554	N/A	N/A	1733	1508	N/A	N/A	1671	N/A	N/A	N/A
B1	1716	1480	N/A	N/A	1653	1428	N/A	N/A	1584	1370	N/A	N/A	1538	N/A	N/A	N/A	1485	N/A	N/A	N/A
B2	1703	1470	N/A	N/A	1641	1419	N/A	N/A	1573	N/A	N/A	N/A	1528	N/A	N/A	N/A	1475	N/A	N/A	N/A
C	1083	N/A	N/A	N/A	1045	N/A	N/A	N/A	N/A	N/A	N/A	N/A	N/A	N/A	N/A	N/A	N/A	N/A	N/A	N/A

Angle	5° < α < 10°																			
TC	2																			
Building Height (m)	< 5				5<H≤10				10<H≤15				15<H≤20				20<H≤30			
	Internal	Intermediate	Edge	Corner	Internal	Intermediate	Edge	Corner	Internal	Intermediate	Edge	Corner	Internal	Intermediate	Edge	Corner	Internal	Intermediate	Edge	Corner
A	1877	1627	N/A	N/A	1746	1519	N/A	N/A	1683	N/A	N/A	N/A	1648	N/A	N/A	N/A	1605	N/A	N/A	N/A
B1	1660	1433	N/A	N/A	1549	N/A	N/A	N/A	1495	N/A	N/A	N/A	1466	N/A	N/A	N/A	1428	N/A	N/A	N/A
B2	1647	1424	N/A	N/A	1538	N/A	N/A	N/A	1486	N/A	N/A	N/A	1457	N/A	N/A	N/A	1419	N/A	N/A	N/A
C	1049	N/A	N/A	N/A	N/A	N/A	N/A	N/A	N/A	N/A	N/A	N/A	N/A	N/A	N/A	N/A	N/A	N/A	N/A	N/A

RACKING

Angle	$\alpha = 10^\circ$																			
TC	3																			
Building Height (m)	< 5				5<H≤10				10<H≤15				15<H≤20				20<H≤30			
	Internal	Intermediate	Edge	Corner	Internal	Intermediate	Edge	Corner	Internal	Intermediate	Edge	Corner	Internal	Intermediate	Edge	Corner	Internal	Intermediate	Edge	Corner
A	1805	1569	N/A	N/A	1805	1569	1458	N/A	1712	1491	N/A	N/A	1644	1434	N/A	N/A	1570	N/A	N/A	N/A
B1	1599	1382	N/A	N/A	1599	1382	N/A	N/A	1521	1316	N/A	N/A	1462	N/A	N/A	N/A	1398	N/A	N/A	N/A
B2	1589	1375	N/A	N/A	1589	1375	N/A	N/A	1510	N/A	N/A	N/A	1452	N/A	N/A	N/A	1390	N/A	N/A	N/A
C	1012	N/A	N/A	N/A	1012	N/A	N/A	N/A	826	N/A	N/A	N/A	N/A	N/A	N/A	N/A	N/A	N/A	N/A	N/A

Angle	$\alpha = 10^\circ$																			
TC	2.5																			
Building Height (m)	< 5				5<H≤10				10<H≤15				15<H≤20				20<H≤30			
	Internal	Intermediate	Edge	Corner	Internal	Intermediate	Edge	Corner	Internal	Intermediate	Edge	Corner	Internal	Intermediate	Edge	Corner	Internal	Intermediate	Edge	Corner
A	1742	1516	N/A	N/A	1677	1462	N/A	N/A	1606	1402	N/A	N/A	1560	N/A	N/A	N/A	1506	N/A	N/A	N/A
B1	1545	1337	N/A	N/A	1490	1290	N/A	N/A	1429	N/A	N/A	N/A	1389	N/A	N/A	N/A	1342	N/A	N/A	N/A
B2	1535	1330	N/A	N/A	1481	N/A	N/A	N/A	1421	N/A	N/A	N/A	1380	N/A	N/A	N/A	1335	N/A	N/A	N/A
C	979	N/A	N/A	N/A	N/A	N/A	N/A	N/A	N/A	N/A	N/A	N/A	N/A	N/A	N/A	N/A	N/A	N/A	N/A	N/A

Angle	$\alpha = 10^\circ$																			
TC	2																			
Building Height (m)	< 5				5<H≤10				10<H≤15				15<H≤20				20<H≤30			
	Internal	Intermediate	Edge	Corner	Internal	Intermediate	Edge	Corner	Internal	Intermediate	Edge	Corner	Internal	Intermediate	Edge	Corner	Internal	Intermediate	Edge	Corner
A	1684	1468	N/A	N/A	1570	N/A	N/A	N/A	1517	N/A	N/A	N/A	1486	N/A	N/A	N/A	1448	N/A	N/A	N/A
B1	1496	1295	N/A	N/A	1398	N/A	N/A	N/A	1351	N/A	N/A	N/A	1325	N/A	N/A	N/A	1291	N/A	N/A	N/A
B2	1487	N/A	N/A	N/A	1390	N/A	N/A	N/A	1343	N/A	N/A	N/A	N/A	N/A	N/A	N/A	N/A	N/A	N/A	N/A
C	N/A	N/A	N/A	N/A	N/A	N/A	N/A	N/A	N/A	N/A	N/A	N/A	N/A	N/A	N/A	N/A	N/A	N/A	N/A	N/A

Angle	$10^\circ < \alpha < 15^\circ$																			
TC	3																			
Building Height (m)	< 5				5<H≤10				10<H≤15				15<H≤20				20<H≤30			
	Internal	Intermediate	Edge	Corner	Internal	Intermediate	Edge	Corner	Internal	Intermediate	Edge	Corner	Internal	Intermediate	Edge	Corner	Internal	Intermediate	Edge	Corner
A	1805	1569	1458	N/A	1805	1569	1458	N/A	1712	1491	N/A	N/A	1644	1434	N/A	N/A	1570	N/A	N/A	N/A
B1	1599	1382	N/A	N/A	1599	1382	N/A	N/A	1521	1316	N/A	N/A	1462	N/A	N/A	N/A	1398	N/A	N/A	N/A
B2	1589	1375	N/A	N/A	1589	1375	N/A	N/A	1510	N/A	N/A	N/A	1452	N/A	N/A	N/A	1390	N/A	N/A	N/A
C	1012	N/A	N/A	N/A	1012	N/A	N/A	N/A	826	N/A	N/A	N/A	N/A	N/A	N/A	N/A	N/A	N/A	N/A	N/A

Angle	$10^\circ < \alpha < 15^\circ$																			
TC	2.5																			
Building Height (m)	< 5				5<H≤10				10<H≤15				15<H≤20				20<H≤30			
	Internal	Intermediate	Edge	Corner	Internal	Intermediate	Edge	Corner	Internal	Intermediate	Edge	Corner	Internal	Intermediate	Edge	Corner	Internal	Intermediate	Edge	Corner
A	1742	1516	N/A	N/A	1677	1462	N/A	N/A	1606	1402	N/A	N/A	1560	N/A	N/A	N/A	1506	N/A	N/A	N/A
B1	1545	1337	N/A	N/A	1490	1290	N/A	N/A	1429	N/A	N/A	N/A	1389	N/A	N/A	N/A	1342	N/A	N/A	N/A
B2	1535	1330	N/A	N/A	1481	N/A	N/A	N/A	1421	N/A	N/A	N/A	1380	N/A	N/A	N/A	1335	N/A	N/A	N/A
C	979	N/A	N/A	N/A	N/A	N/A	N/A	N/A	N/A	N/A	N/A	N/A	N/A	N/A	N/A	N/A	N/A	N/A	N/A	N/A

Angle	$10^\circ < \alpha < 15^\circ$																			
TC	2																			
Building Height (m)	< 5				5<H≤10				10<H≤15				15<H≤20				20<H≤30			
	Internal	Intermediate	Edge	Corner	Internal	Intermediate	Edge	Corner	Internal	Intermediate	Edge	Corner	Internal	Intermediate	Edge	Corner	Internal	Intermediate	Edge	Corner
A	1684	1468	N/A	N/A	1570	N/A	N/A	N/A	1517	N/A	N/A	N/A	1486	N/A	N/A	N/A	1448	N/A	N/A	N/A
B1	1496	1295	N/A	N/A	1398	N/A	N/A	N/A	1351	N/A	N/A	N/A	1325	N/A	N/A	N/A	1291	N/A	N/A	N/A
B2	1487	N/A	N/A	N/A	1390	N/A	N/A	N/A	1343	N/A	N/A	N/A	N/A	N/A	N/A	N/A	N/A	N/A	N/A	N/A
C	N/A	N/A	N/A	N/A	N/A	N/A	N/A	N/A	N/A	N/A	N/A	N/A	N/A	N/A	N/A	N/A	N/A	N/A	N/A	N/A

Angle	$\alpha = 15^\circ$																			
TC	3																			
Building Height (m)	< 5				5<H≤10				10<H≤15				15<H≤20				20<H≤30			
	Internal	Intermediate	Edge	Corner	Internal	Intermediate	Edge	Corner	Internal	Intermediate	Edge	Corner	Internal	Intermediate	Edge	Corner	Internal	Intermediate	Edge	Corner
A	1725	1501	N/A	N/A	1725	1501	N/A	N/A	1637	N/A	N/A	N/A	1572	N/A	N/A	N/A	1504	N/A	N/A	N/A
B1	1531	N/A	N/A	N/A	1531	N/A	N/A	N/A	1456	N/A	N/A	N/A	1400	N/A	N/A	N/A	1340	N/A	N/A	N/A
B2	1520	N/A	N/A	N/A	1520	N/A	N/A	N/A	1447	N/A	N/A	N/A	1391	N/A	N/A	N/A	N/A	N/A	N/A	N/A
C	N/A	N/A	N/A	N/A	N/A	N/A	N/A	N/A	N/A	N/A	N/A	N/A	N/A	N/A	N/A	N/A	N/A	N/A	N/A	N/A

Angle	$\alpha = 15^\circ$																			
TC	2.5																			
Building Height (m)	< 5				5<H≤10				10<H≤15				15<H≤20				20<H≤30			
	Internal	Intermediate	Edge	Corner	Internal	Intermediate	Edge	Corner	Internal	Intermediate	Edge	Corner	Internal	Intermediate	Edge	Corner	Internal	Intermediate	Edge	Corner
A	1665	N/A	N/A	N/A	1604	N/A	N/A	N/A	1538	N/A	N/A	N/A	1493	N/A	N/A	N/A	1442	N/A	N/A	N/A
B1	1480	N/A	N/A	N/A	1428	N/A	N/A	N/A	1370	N/A	N/A	N/A	N/A	N/A	N/A	N/A	N/A	N/A	N/A	N/A
B2	1470	N/A	N/A	N/A	1419	N/A	N/A	N/A	N/A	N/A	N/A	N/A	N/A	N/A	N/A	N/A	N/A	N/A	N/A	N/A
C	N/A	N/A	N/A	N/A	N/A	N/A	N/A	N/A	N/A	N/A	N/A	N/A	N/A	N/A	N/A	N/A	N/A	N/A	N/A	N/A



**NOTE** – Spacing tables are subject to use of specified rails and accessories as per Clenergy Installation guides and General Certificates.

Scan the QR Code:



Link1



Link2

These documents are also available on the dealer portal -

<https://www.solahart.com.au/dealers/pv-and-batteries/panels-racking/clenergy-racking/>

**MAXIMUM RAIL SUPPORT SPACING FOR TILT LEG SYSTEMS FOR ECO RAILS**

Please design the system for tilt legs, as per site conditions and considering the bifacial gain from the rear side

Use the following tables to determine the maximum rail support spacing for the relevant roof type based on the previously determined wind region, terrain category, roof pitch, roof position area (Corner Zone, Edge Zone, Intermediate Zone, or Internal Zone) and maximum height of the installation. The maximum spacing values below are in metres.

⚠ **Warning:** the following tables cover the only installations permitted for SOLAHART440BRB2 modules based on mechanical design load of 3600/1600 Pa.

⚠ **Warning:** Installation is prohibited if the spacing is **N/A**.

**TABLE-5 TILT INTERFACE SPACING FOR ECO RAILS**  
SOLAR PANEL SIZE 1762 x 1134 x 30 mm

		ANGLE TO THE HORIZONTAL 0° ≤ α < 10°															
TC		3															
BUILDING HEIGHT (m)	< 5				5≤H<10				10≤H<15				15≤H<20				
	Internal	Intermediate	Edge	Corner	Internal	Intermediate	Edge	Corner	Internal	Intermediate	Edge	Corner	Internal	Intermediate	Edge	Corner	
A	2.179	1.743	1.321	N/A	1.983	1.586	1.202	N/A	1.918	1.534	1.162	N/A	1.602	1.281	N/A	N/A	
B1	1.884	1.295	0.981	N/A	1.522	1.218	0.922	N/A	1.490	1.192	N/A	N/A	1.263	1.010	N/A	N/A	
B2	1.869	1.286	N/A	N/A	1.509	1.209	N/A	N/A	1.478	1.184	N/A	N/A	1.254	1.004	N/A	N/A	
C	1.449	N/A	N/A	N/A	1.193	N/A	N/A	N/A	1.142	N/A	N/A	N/A	0.838	0.670	N/A	N/A	

		0° ≤ α < 10°															
TC		2.5															
BUILDING HEIGHT (m)	< 5				5≤H<10				10≤H<15				15≤H<20				
	Internal	Intermediate	Edge	Corner	Internal	Intermediate	Edge	Corner	Internal	Intermediate	Edge	Corner	Internal	Intermediate	Edge	Corner	
A	2.092	1.674	1.268	N/A	1.904	1.523	N/A	N/A	1.841	1.473	N/A	N/A	1.538	1.230	N/A	N/A	
B1	1.809	1.244	N/A	N/A	1.461	1.169	N/A	N/A	1.430	1.144	N/A	N/A	1.212	N/A	N/A	N/A	
B2	1.794	1.235	N/A	N/A	1.450	1.161	N/A	N/A	1.420	N/A	N/A	N/A	1.205	N/A	N/A	N/A	
C	1.391	N/A	N/A	N/A	1.145	N/A	N/A	N/A	N/A	N/A	N/A	N/A	N/A	N/A	N/A	N/A	

ANGLE TO THE HORIZONTAL		0° ≤ α < 10°															
TC		2															
BUILDING HEIGHT (m)	< 5				5≤H<10				10≤H<15				15≤H<20				
	Internal	Intermediate	Edge	Corner	Internal	Intermediate	Edge	Corner	Internal	Intermediate	Edge	Corner	Internal	Intermediate	Edge	Corner	
A	2.037	1.630	N/A	N/A	1.854	1.483	N/A	N/A	1.793	N/A	N/A	N/A	1.497	N/A	N/A	N/A	
B1	1.694	1.211	N/A	N/A	1.423	N/A	N/A	N/A	1.393	N/A	N/A	N/A	1.181	N/A	N/A	N/A	
B2	1.634	1.203	N/A	N/A	1.413	N/A	N/A	N/A	1.384	N/A	N/A	N/A	1.174	N/A	N/A	N/A	
C	1.266	N/A	N/A	N/A	N/A	N/A	N/A	N/A	N/A	N/A	N/A	N/A	N/A	N/A	N/A	N/A	

ANGLE TO THE HORIZONTAL		10° ≤ α < 15°															
TC		3															
BUILDING HEIGHT (m)	< 5				5≤H<10				10≤H<15				15≤H<20				
	Internal	Intermediate	Edge	Corner	Internal	Intermediate	Edge	Corner	Internal	Intermediate	Edge	Corner	Internal	Intermediate	Edge	Corner	
A	1.943	1.586	1.202	N/A	1.785	1.428	1.082	N/A	1.666	1.333	N/A	N/A	1.405	1.124	N/A	N/A	
B1	1.409	1.128	N/A	N/A	1.198	0.958	N/A	N/A	1.015	0.812	N/A	N/A	0.989	N/A	N/A	N/A	
B2	1.399	1.084	N/A	N/A	1.189	0.921	N/A	N/A	1.008	N/A	N/A	N/A	0.984	N/A	N/A	N/A	
C	1.285	N/A	N/A	N/A	0.913	N/A	N/A	N/A	N/A	N/A	N/A	N/A	N/A	N/A	N/A	N/A	

ANGLE TO THE HORIZONTAL		10° ≤ α < 15°															
TC		2.5															
BUILDING HEIGHT (m)	< 5				5≤H<10				10≤H<15				15≤H<20				
	Internal	Intermediate	Edge	Corner	Internal	Intermediate	Edge	Corner	Internal	Intermediate	Edge	Corner	Internal	Intermediate	Edge	Corner	
A	1.866	1.523	N/A	N/A	1.713	1.371	N/A	N/A	1.599	1.279	N/A	N/A	1.349	N/A	N/A	N/A	
B1	1.353	1.082	N/A	N/A	1.150	0.920	N/A	N/A	0.974	N/A	N/A	N/A	0.950	N/A	N/A	N/A	
B2	1.344	1.005	N/A	N/A	1.143	N/A	N/A	N/A	0.968	N/A	N/A	N/A	0.921	N/A	N/A	N/A	
C	1.234	N/A	N/A	N/A	N/A	N/A	N/A	N/A	N/A	N/A	N/A	N/A	N/A	N/A	N/A	N/A	

ANGLE TO THE HORIZONTAL		10° ≤ α < 15°															
TC		2															
BUILDING HEIGHT (m)	< 5				5≤H<10				10≤H<15				15≤H<20				
	Internal	Intermediate	Edge	Corner	Internal	Intermediate	Edge	Corner	Internal	Intermediate	Edge	Corner	Internal	Intermediate	Edge	Corner	
A	1.817	1.483	N/A	N/A	1.669	N/A	N/A	N/A	1.557	N/A	N/A	N/A	1.314	N/A	N/A	N/A	
B1	1.318	1.054	N/A	N/A	1.120	N/A	N/A	N/A	0.949	N/A	N/A	N/A	0.925	N/A	N/A	N/A	
B2	1.309	N/A	N/A	N/A	1.102	N/A	N/A	N/A	0.881	N/A	N/A	N/A	N/A	N/A	N/A	N/A	
C	N/A	N/A	N/A	N/A	N/A	N/A	N/A	N/A	N/A	N/A	N/A	N/A	N/A	N/A	N/A	N/A	

ANGLE TO THE HORIZONTAL		15° ≤ α < 20°															
TC		3															
BUILDING HEIGHT (m)	< 5				5≤H<10				10≤H<15				15≤H<20				
	Internal	Intermediate	Edge	Corner	Internal	Intermediate	Edge	Corner	Internal	Intermediate	Edge	Corner	Internal	Intermediate	Edge	Corner	
A	1.753	1.499	N/A	N/A	1.537	1.229	N/A	N/A	1.499	N/A	N/A	N/A	1.328	N/A	N/A	N/A	
B1	1.271	N/A	N/A	N/A	0.954	N/A	N/A	N/A	0.890	N/A	N/A	N/A	0.749	N/A	N/A	N/A	
B2	1.263	N/A	N/A	N/A	0.948	N/A	N/A	N/A	0.873	N/A	N/A	N/A	0.696	N/A	N/A	N/A	
C	N/A	N/A	N/A	N/A	N/A	N/A	N/A	N/A	N/A	N/A	N/A	N/A	N/A	N/A	N/A	N/A	

# RACKING

ANGLE TO THE HORIZONTAL	15° ≤ α < 20°															
TC	2.5															
BUILDING HEIGHT (m)	< 5				5≤H<10				10≤H<15				15≤H<20			
	Internal	Intermediate	Edge	Corner	Internal	Intermediate	Edge	Corner	Internal	Intermediate	Edge	Corner	Internal	Intermediate	Edge	Corner
A	1.763	N/A	N/A	N/A	1.475	N/A	N/A	N/A	1.439	N/A	N/A	N/A	1.275	N/A	N/A	N/A
B1	1.221	N/A	N/A	N/A	0.915	N/A	N/A	N/A	0.854	N/A	N/A	N/A	N/A	N/A	N/A	N/A
B2	1.213	N/A	N/A	N/A	0.864	N/A	N/A	N/A	N/A	N/A	N/A	N/A	N/A	N/A	N/A	N/A
C	N/A	N/A	N/A	N/A	N/A	N/A	N/A	N/A	N/A	N/A	N/A	N/A	N/A	N/A	N/A	N/A

ANGLE TO THE HORIZONTAL	15° ≤ α < 20°															
TC	2															
BUILDING HEIGHT (m)	< 5				5≤H<10				10≤H<15				15≤H<20			
	Internal	Intermediate	Edge	Corner	Internal	Intermediate	Edge	Corner	Internal	Intermediate	Edge	Corner	Internal	Intermediate	Edge	Corner
A	1.633	N/A	N/A	N/A	1.437	N/A	N/A	N/A	1.402	N/A	N/A	N/A	N/A	N/A	N/A	N/A
B1	1.189	N/A	N/A	N/A	0.892	N/A	N/A	N/A	N/A	N/A	N/A	N/A	N/A	N/A	N/A	N/A
B2	1.131	N/A	N/A	N/A	N/A	N/A	N/A	N/A	N/A	N/A	N/A	N/A	N/A	N/A	N/A	N/A
C	N/A	N/A	N/A	N/A	N/A	N/A	N/A	N/A	N/A	N/A	N/A	N/A	N/A	N/A	N/A	N/A

ANGLE TO THE HORIZONTAL	20° ≤ α < 25°															
TC	3															
BUILDING HEIGHT (m)	< 5				5≤H<10				10≤H<15				15≤H<20			
	Internal	Intermediate	Edge	Corner	Internal	Intermediate	Edge	Corner	Internal	Intermediate	Edge	Corner	Internal	Intermediate	Edge	Corner
A	1.633	N/A	N/A	N/A	1.403	N/A	N/A	N/A	1.368	N/A	N/A	N/A	1.152	N/A	N/A	N/A
B1	1.147	N/A	N/A	N/A	0.860	N/A	N/A	N/A	0.803	N/A	N/A	N/A	N/A	N/A	N/A	N/A
B2	1.085	N/A	N/A	N/A	0.814	N/A	N/A	N/A	N/A	N/A	N/A	N/A	N/A	N/A	N/A	N/A
C	N/A	N/A	N/A	N/A	N/A	N/A	N/A	N/A	N/A	N/A	N/A	N/A	N/A	N/A	N/A	N/A

ANGLE TO THE HORIZONTAL	20° ≤ α < 25°															
TC	2.5															
BUILDING HEIGHT (m)	< 5				5≤H<10				10≤H<15				15≤H<20			
	Internal	Intermediate	Edge	Corner	Internal	Intermediate	Edge	Corner	Internal	Intermediate	Edge	Corner	Internal	Intermediate	Edge	Corner
A	1.642	N/A	N/A	N/A	1.347	N/A	N/A	N/A	N/A	N/A	N/A	N/A	N/A	N/A	N/A	N/A
B1	1.101	N/A	N/A	N/A	0.826	N/A	N/A	N/A	N/A	N/A	N/A	N/A	N/A	N/A	N/A	N/A
B2	1.023	N/A	N/A	N/A	N/A	N/A	N/A	N/A	N/A	N/A	N/A	N/A	N/A	N/A	N/A	N/A
C	N/A	N/A	N/A	N/A	N/A	N/A	N/A	N/A	N/A	N/A	N/A	N/A	N/A	N/A	N/A	N/A

ANGLE TO THE HORIZONTAL	20° ≤ α < 25°															
TC	2															
BUILDING HEIGHT (m)	< 5				5≤H<10				10≤H<15				15≤H<20			
	Internal	Intermediate	Edge	Corner	Internal	Intermediate	Edge	Corner	Internal	Intermediate	Edge	Corner	Internal	Intermediate	Edge	Corner
A	1.527	N/A	N/A	N/A	N/A	N/A	N/A	N/A	N/A	N/A	N/A	N/A	N/A	N/A	N/A	N/A
B1	1.072	N/A	N/A	N/A	N/A	N/A	N/A	N/A	N/A	N/A	N/A	N/A	N/A	N/A	N/A	N/A
B2	N/A	N/A	N/A	N/A	N/A	N/A	N/A	N/A	N/A	N/A	N/A	N/A	N/A	N/A	N/A	N/A
C	N/A	N/A	N/A	N/A	N/A	N/A	N/A	N/A	N/A	N/A	N/A	N/A	N/A	N/A	N/A	N/A

ANGLE TO THE HORIZONTAL	25° ≤ α < 30°															
TC	3															
BUILDING HEIGHT (m)	< 5				5≤H<10				10≤H<15				15≤H<20			
	Internal	Intermediate	Edge	Corner	Internal	Intermediate	Edge	Corner	Internal	Intermediate	Edge	Corner	Internal	Intermediate	Edge	Corner
A	1.591	N/A	N/A	N/A	1.304	N/A	N/A	N/A	1.273	N/A	N/A	N/A	N/A	N/A	N/A	N/A
B1	1.041	N/A	N/A	N/A	0.728	N/A	N/A	N/A	N/A	N/A	N/A	N/A	N/A	N/A	N/A	N/A
B2	N/A	N/A	N/A	N/A	N/A	N/A	N/A	N/A	N/A	N/A	N/A	N/A	N/A	N/A	N/A	N/A
C	N/A	N/A	N/A	N/A	N/A	N/A	N/A	N/A	N/A	N/A	N/A	N/A	N/A	N/A	N/A	N/A

ANGLE TO THE HORIZONTAL	25° ≤ α < 30°															
TC	2.5															
BUILDING HEIGHT (m)	< 5				5≤H<10				10≤H<15				15≤H<20			
	Internal	Intermediate	Edge	Corner	Internal	Intermediate	Edge	Corner	Internal	Intermediate	Edge	Corner	Internal	Intermediate	Edge	Corner
A	1.527	N/A	N/A	N/A	N/A	N/A	N/A	N/A	N/A	N/A	N/A	N/A	N/A	N/A	N/A	N/A
B1	N/A	N/A	N/A	N/A	N/A	N/A	N/A	N/A	N/A	N/A	N/A	N/A	N/A	N/A	N/A	N/A
B2	N/A	N/A	N/A	N/A	N/A	N/A	N/A	N/A	N/A	N/A	N/A	N/A	N/A	N/A	N/A	N/A
C	N/A	N/A	N/A	N/A	N/A	N/A	N/A	N/A	N/A	N/A	N/A	N/A	N/A	N/A	N/A	N/A

**NOTE** – Spacing tables are subject to use of specified rails and accessories as per Clenergy Installation guides and General Certificates.

Link: <https://www.clenergy.com.au/wp-content/uploads/2023/03/Clenergy-PVezRack-SolarRoof-Penetrative-Tilt-Legs-installationguide-english.pdf>

QR Code Link





Steel purlins must meet the following minimum requirements:

Roof interface	Minimum steel purlin specification
Metal roof interface	1.50 mm BMT G450 Grade
Tilt leg interface	Min 2 screws at 1.5 mm BMT G450 Grade

Roof interfaces must be fixed to rafters or purlins under the roof cladding. Screw minimum embedment into timber rafters or battens is 35 mm.

**Note:** Screws supplied with the roof interfaces are wood screws suitable for timber only. Screws used in metal purlins must be suitable for metal structures and have a TPI (threads per inch) of 14.

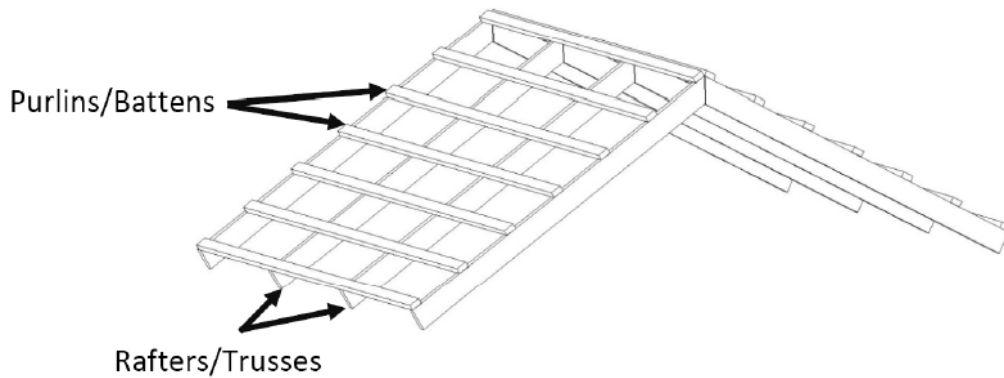

**RAIL SPACING**

Rails should be spaced so that the module is clamped in the correct positions. Refer to “Module Mounting” on page 51.

In general, the rails may be spaced between 830 mm and 1230 mm apart.

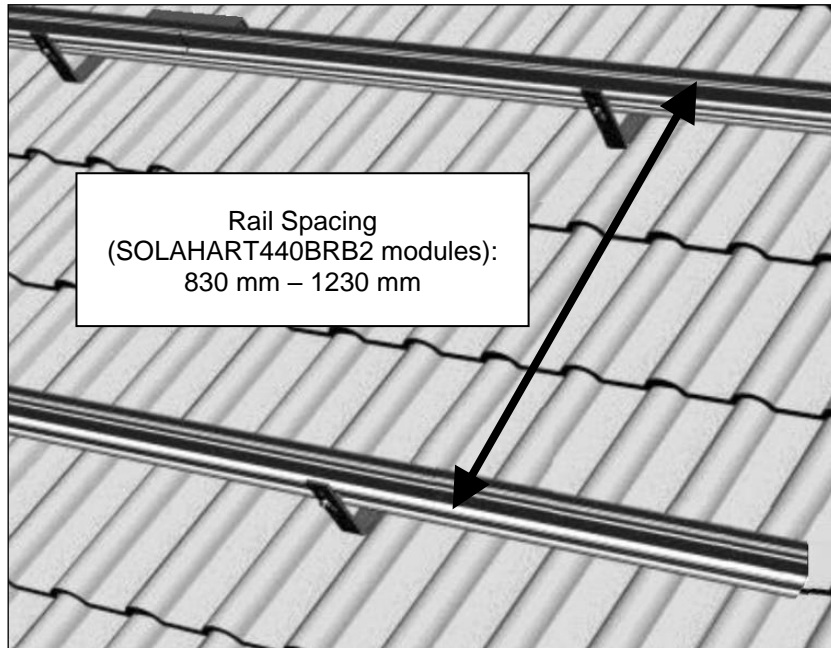

**RAIL OVERHANG**

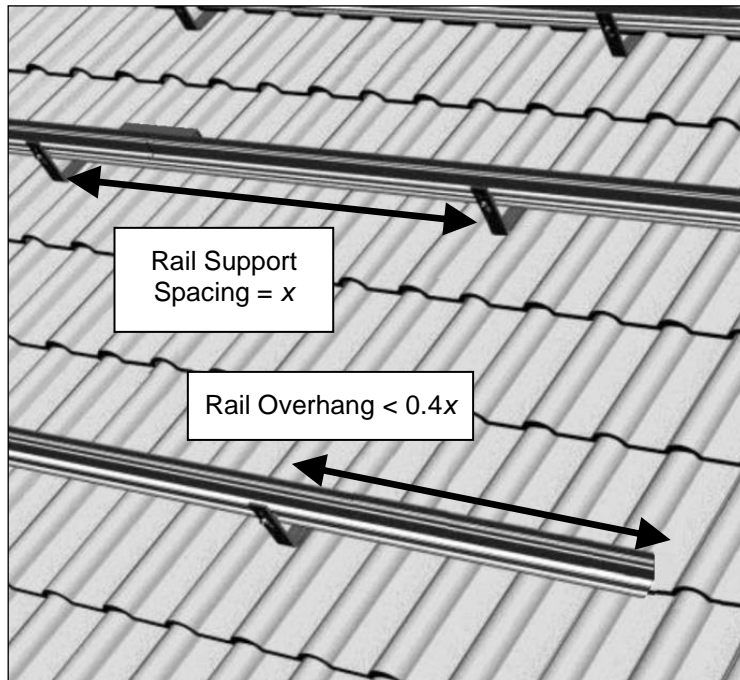

Rail end overhang should not be over 40% of the interface spacing. For example, if the interface spacing is 1500mm, the Rail end overhang can be up to 600mm only.



**Note:** Drawings not to scale

## TILE ROOF INSTALLATION

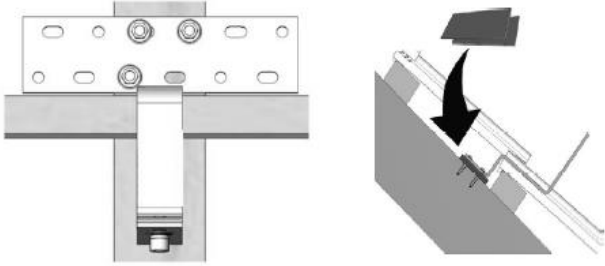
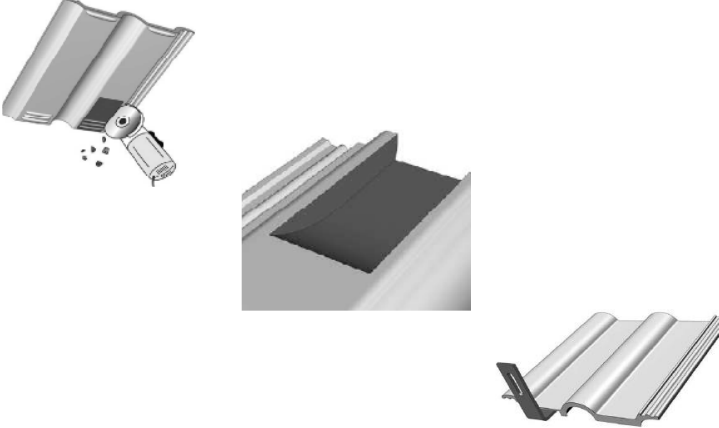
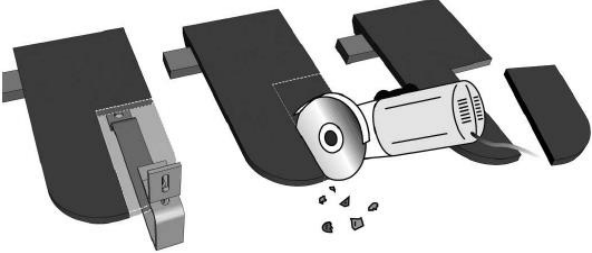
**Note:** The tile roof interface is only suitable for installation on timber rafters.

<p>1. Determine and mark the position of the tile roof interfaces according to your plans. Remove the roof tiles at marked positions or, if possible, simply move the tiles up slightly.</p>	
<p>2. Fix the tile roof interfaces to rafters using three M6 X 80 mm wood screws. Ensure a 50 mm minimum screw embedment into the rafters.</p> <p><b>Warning:</b> Tile roof interfaces must not press against roof tiles and must be fixed parallel with rafters. If necessary, pack underneath tile roof interfaces with timber.</p>	
<p>3. For thick tiles (such as grooved tiles), if necessary, use an angle grinder to chase a recess (or remove raised grooves) on the tile that covers the tile roof interface at the point where the interface protrudes through so that the tile lies flat.</p> <p>For thick tiles it may also be necessary to cut a recess into the tile located below the tile roof interface.</p> <p>Now proceed to installation of the rails. Refer to "Rail Installation" on page 38.</p>	
<p>4. For thin tiles (such as slate, shingles), a portion of tile must be cut and removed from the tile above the tile roof interface, creating a recess.</p> <p>Suitable flashing must then be installed around the tile roof interface, with an overlap of at least 150 mm at the edges of the recess.</p> <p>Now proceed to installation of the rails. Refer to "Rail Installation" on page 38.</p>	
<p><b>Warning:</b> Do not use tile roof interfaces as a climbing support as extreme loading of this point could cause damage to the tile below.</p>	

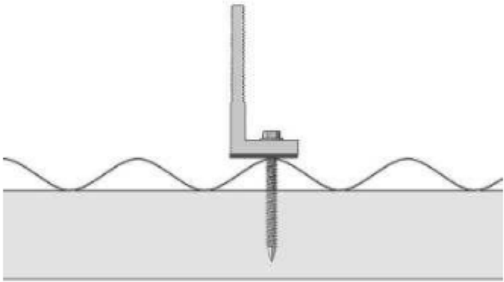
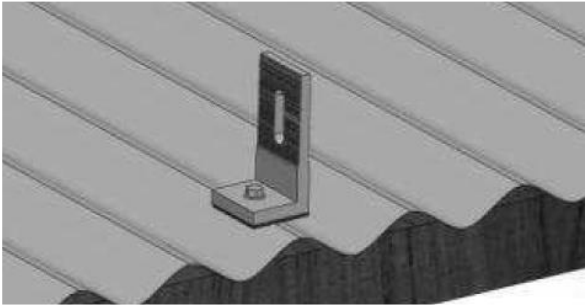

**METAL ROOF INSTALLATION**

**Note:** Screws supplied with the roof interfaces are wood screws suitable for timber only. Screws used in metal purlins must be suitable for metal structures and have a TPI (threads per inch) of 14.

<p>1. Determine and mark position of the metal roof interface according to your plans. Pre drill through roof cladding (on top of crest) at planned locations. Place the supplied rubber gasket under the metal roof interface and ensure that a weatherproof seal is made between the interface and the roof cladding.</p>	
<p>2. Fix the metal roof interface to the timber batten or rafter using the M6 x 90 mm screw supplied.</p> <p>Ensure a 35 mm minimum screw embedment for timber battens and rafters.</p> <p>If the interface is being fixed to metal purlins use screws suitable for metal structures with a TPI of 14.</p>	
<p>3. Check the metal roof interface to ensure that the fastening screw tightly fixes sealing gasket without damaging roof cladding.</p> <p>Now proceed to installation of the rails. Refer to “Rail Installation” on page 38.</p>	

## TILT LEG INSTALLATION (PLEASE REDESIGN THE SYSTEM TO SUIT TILT LEGS INCLUDING BIFACIAL GAIN)

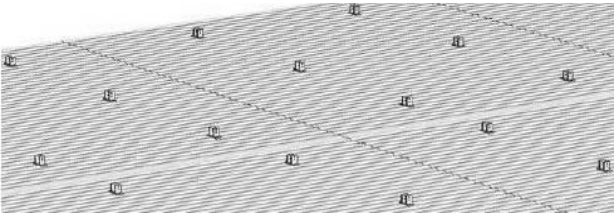
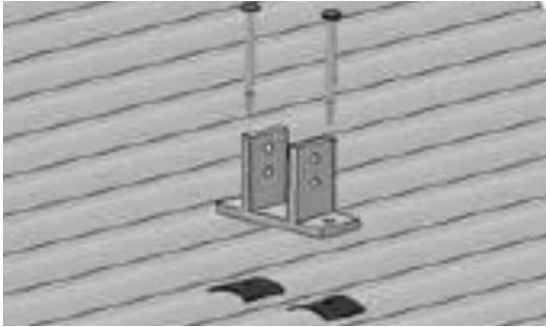
**Note:** Screws supplied with the tilt legs are wood screws suitable for timber only. Screws used in metal purlins must be suitable for metal structures and have a TPI (threads per inch) of 14.

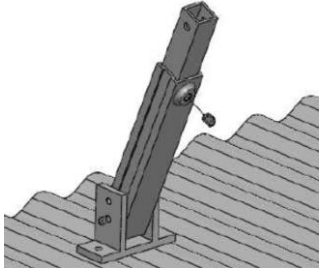
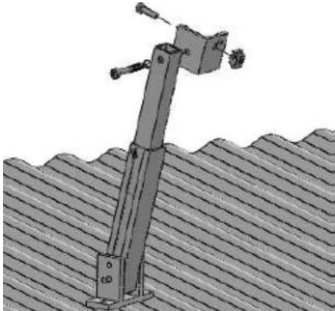
<p>1. Determine and mark position of front feet according to your plans. Pre drill through roof cladding (on top of crest) at planned locations. Place the supplied rubber gaskets under each foot and ensure that a weatherproof seal is made between the foot and the roof cladding.</p>	
<p>2. Fix the foot to the timber batten or rafter using a minimum of two M6 X 80 mm screws.</p> <p>Ensure a minimum screw embedment of 35 mm for timber battens and rafters.</p> <p>If the interface is being fixed to metal purlins use screws suitable for metal structures with a TPI of 14.</p> <p>Check the foot to ensure that the fastening screws tightly fix the sealing gaskets without damaging roof cladding.</p>	
<p>3. The U Bracket comes preassembled with the front foot. Loosely fasten Allen head bolt and nut to allow for later adjustment. Allen head bolt and Z-module on top of U bracket is utilised to attach rails in next step.</p>	
<p>4. Place rear legs into feet, insert Allen head bolt, washer, retaining washer and nut and fasten loosely to allow for later adjustment.</p>	
<p>5. Loosen the leg telescopic section Allen head grub screws. Adjust the leg length according to your plans and tighten the grub screws to 17 Nm.</p>	
<p>6. Fix the leg L bracket to the leg using the Allen head bolt, washer, retaining washer and nut and fasten loosely to allow for later adjustment.</p> <ul style="list-style-type: none"> <li>• Minimum back leg angle to horizontal is 30°.</li> <li>• Maximum back leg angle to horizontal is 90°.</li> </ul>	

**RAIL INSTALLATION**

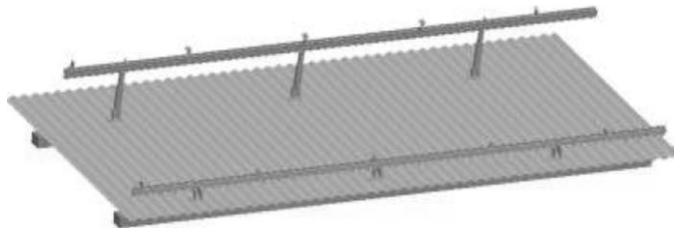
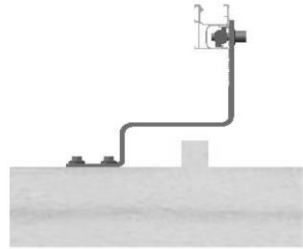
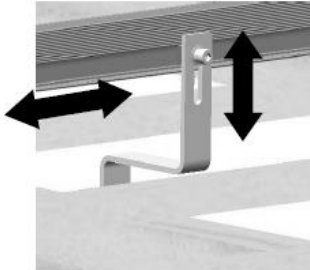
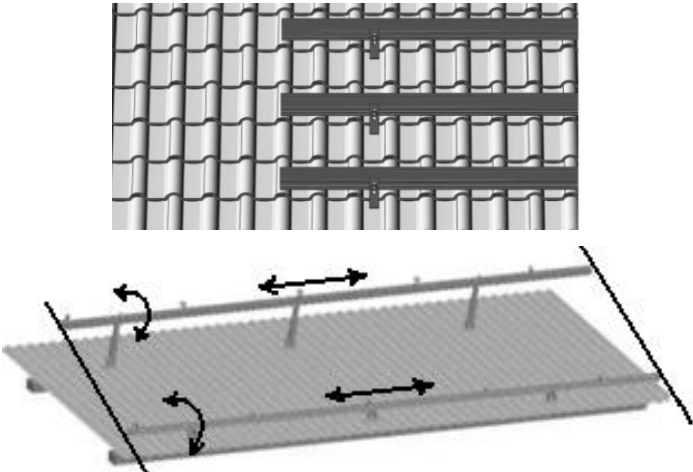
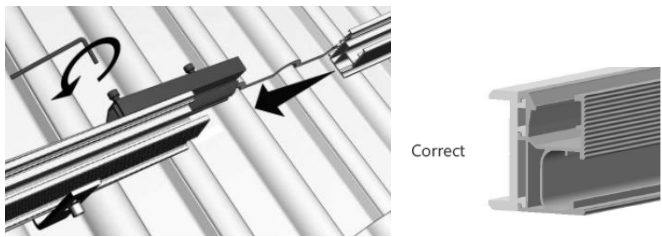
<p>1. Install rails onto the roof interfaces. If the assembly consists of rails of different lengths, always begin with the shortest piece. Install the rail loosely onto the roof interfaces using the Allen head bolt, washer, retaining washer and Z-modules supplied (2 to 3 turns of the bolt are adequate for loose installation). Refer to step 2 for method of inserting Z-module into rail.</p>	
<p>2. For easy use of Z-modules ensure that Allen head bolt threads do not project through lower side of Z-module so that the Z-module is free to move. Position Z-modules in rail channel as shown and fasten loosely with 2 to 3 turns of Z-module Allen head bolt. The rail can then be freely moved along Z-modules.</p>	
<p>3. Adjust the vertical and horizontal position of the rail by taking advantage of the long hole in the tile and metal roof interfaces and the still loose connection of the rail Z-modules.</p>	
<p>4. Align all rail ends.</p> <p>Align the rail tilt orientation (use a string line if necessary).</p> <p>Tighten all previously loosely installed rail and feet Z-module Allen head bolts to a torque of 18-20 Nm.</p>	
<p>5. To connect multiple rails together, slide a splice on to the rear side of the previously assembled rail. Tighten the first splice Allen head bolt to 18-20 Nm. Slide the next rail segment into the splice. An expansion gap at the rail joints is recommended. Leave a gap of approximately 10 mm between the rail joints and then tighten the second Allen head bolt to 18-20 Nm.</p>	

---

# ROOFTOP ISOLATOR





---

The rooftop DC isolator must be mounted to the rail by following the steps below. To help prevent UV degradation, the rooftop isolator should be mounted as far from the north side of the array as possible.

When installing the rooftop isolator the following points should be observed:

- Ensure the IP rating of the isolator enclosure is maintained and that no moisture can enter.
- Cable glands and conduit adapters must be chosen to suit the type of cable or conduit used. E.g. cable glands designed for figure-8 cables must be chosen where figure-8 type solar DC cables are utilised.
- Any conduit adapters should be installed so that the conduit slopes downwards from the enclosure to prevent water ingress in adverse weather conditions.
- If water and/or condensation can form in the isolator enclosure, provision must be made for its harmless escape through suitably located drainage points in accordance with AS/NZS 3000 Clause 3.3.2.3. Conduit entering the isolator enclosure must have a drainage hole installed at the lowest point to facilitate the escape of any moisture.

**Note:** Install rooftop isolators before installing any PV modules.

<p>Step 1: Mount the isolator enclosure onto the bracket using 4 x M4 12mm stainless steel bolts, nuts and washers as illustrated in Figure 1.</p> <p>Install screw cover caps and seal all mounting holes with silicon to prevent water ingress.</p>	 <p>Figure 1</p>
<p>Step 2: Mount the Z-modules loosely onto the isolator bracket as shown in Figure 2.</p> <p>Note: If the clearance below the PV modules is less than 110 mm, the Z-modules can be fitted onto the bottom two slots on the isolator bracket as shown in Figure 3.</p>	  <p>Figure 2</p> <p>Figure 3</p>
<p>Step 3: Insert Z-modules into the channel of the rail and move the isolator bracket to the desired location. Insert an earthing plate in between the rail and the bracket as shown in figure 4. Tighten the bolts to 13-14 Nm.</p> <p>Note: Both Z-modules must be secured to the rail. Extend the rail if required.</p>	 <p>Figure 4</p>

**Note** - Installations without DC Isolators will instead use a Disconnection Point (DP) in accordance with the AS/NZS 5033:2021. Label and signage requirement of DP type installation is different, refer the Labelling section for more details.

---

# WIRING

---

## WIRING

Only UV-resistant cables and connectors approved for outside use should be used. PV cable must be marked or labelled in accordance with AS/NZS 5033.

To minimise the risk of indirect lightning strikes, avoid forming closed loops when designing the system. Check to ensure that system wiring is correct before commissioning modules. If the measured open circuit voltage ( $V_{oc}$ ) and short circuit current ( $I_{sc}$ ) differ from specifications, a wiring fault may be present.

Recommended cable size for plug connectors is 4 – 6 mm<sup>2</sup>, with an operating temperature range of -40 to +120°C. Plug connectors are polarised and should be firmly connected. All connections should be secure, tight and electrically and mechanically sound. Correct DC polarity should be observed at all times. Plug connectors should never be used to turn the system on or off (i.e. do not connect or disconnect plug connectors under load conditions).

Only use plug connectors supplied with your Solahart PV system, or which are the same type/model and from the same manufacturer as those on the PV module. Ensure that all plug connectors and plug wiring are in good electrical and mechanical condition and are not subjected to mechanical stress.

Ensure that all materials meet system requirements such as maximum voltage, current, moisture and temperature when exposed to sunlight.

Electrical ratings of the PV modules are within 3% of measured values at Standard Test Conditions (STC). Under normal conditions, a photovoltaic module may experience conditions that produce more current and/or voltage than that reported under STC. When designing a system, allow for increased output of a module as a result of conditions different to STC in accordance with the Clean Energy Council's "Grid-Connected Solar PV System - Design Guidelines for Accredited Installers" and AS/NZS 5033.

Ensure cables are fixed to the mounting structure and are not in contact with the roof or rear surface of module(s) by using restraining devices which are sunlight and UV-resistant.

**Note:** Plastic cable ties are not to be used as primary means of support.

A roof flashing such as a Dektite® must be used where wiring penetrates tile or metal roofing. Flashings must be sealed using an appropriate waterproofing compound such as silicone.



All wiring must be protected from mechanical damage and external wiring must be protected from UV and mechanical damage in such a manner that it will last the life of the system. All conduits shall comply with AS/NZS 2053.1 and if exposed to sunlight must be suitably UV rated and marked with the letter "T". Do not install wiring such that it is subject to permanent tension.

## COMPONENT PLUG AND DC CABLE SIZING TABLE

Cabling	Plug	Cable Size	Plug Rating
Module fly leads	Pre crimped on fly leads	4 mm <sup>2</sup>	IP67
Module DC extension leads	PV-CAB-MC12 supplied as individual pack of 12m cable pre-crimped with MC4 connectors	Min 4 mm <sup>2</sup>	IP67
Wiring – Roof isolator to inverter isolator <sup>(a)</sup>	Not required – hard wired	Min 4 mm <sup>2</sup>	N/A
Wiring – Inverter isolator to inverter	As supplied with inverter	Min 4 mm <sup>2</sup>	IP67

<sup>(a)</sup> = DC cable supplied by installer.

All cables/wiring are double insulated Solar DC type cable.

It is recommended the maximum voltage drop between the PV array and the inverter is 3%.

---



### DC ISOLATOR WIRING

The DC isolators utilised in Solahart PV Systems are not polarity sensitive (non polarised type) however for uniformity they should be wired as shown in the DC isolator wiring diagram below.

**⚠ Warning:** DC isolator terminal screws must be tightened by hand only. Do not use power tools.

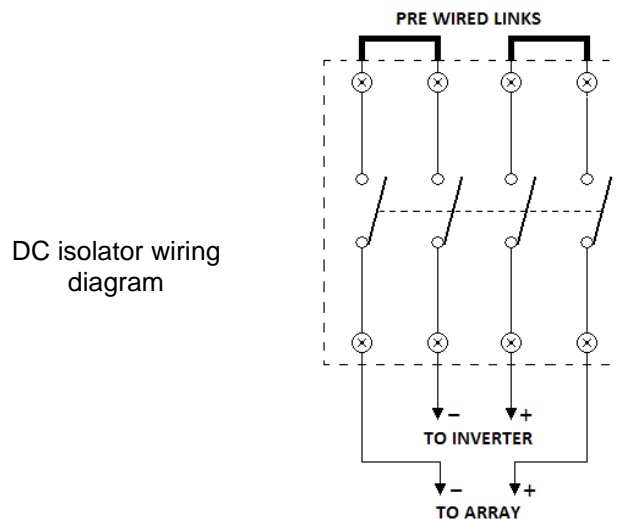

Once wired, the DC isolator should be left in the open position until system commissioning.

### NON LOAD BREAKING DISCONNECTION DEVICE - DISCONNECTION POINT

As per AS/NZS 5033:2021, a non-load breaking disconnection point can be used in place of a DC Isolator, provided all requirements of the standard are met. When using disconnection point, they should be labelled in accordance with the AS/NZS 5033:2021.

Non-load break switch disconnectors and circuit breakers not capable of breaking load under current shall be marked as “no-load break”. They shall not be able to be operated without the use of tool.

---

## POWER OPTIMISERS (SOLAREEDGE)

---

**⚠ Warning:** Input and output connectors are not watertight until mated. Open connectors should be mated to each other or plugged with appropriate watertight caps.

**⚠ Warning:** Cutting the power optimizer input or output cables is prohibited and will void product warranty.

**⚠ Warning:** Do not connect / disconnect DC connectors or wiring while under load.

**⚠ Warning:** Only connectors of the same make and model may be connected together.

**Note:** Modules with SolarEdge power optimizers output a low safety voltage before the inverter is turned ON. As long as the power optimizers are not connected to the inverter or the inverter is turned OFF, each power optimizer will output a safe voltage of 1 V ( $\pm 0.1$  V).

### MOUNTING THE POWER OPTIMIZERS

1. Determine and mark the power optimizer mounting locations on the rail:
  - a. Power optimizers should be spaced approximately 1154 mm apart on the rail. See figure below.

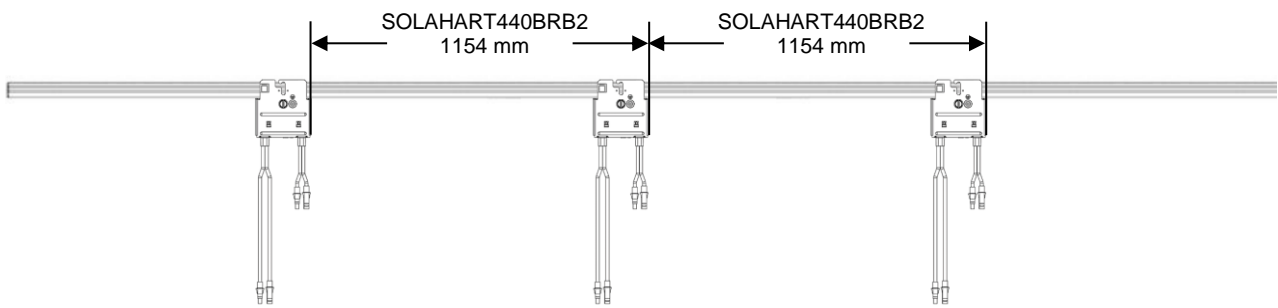

**Note:** Figure is not to scale.

- b. Power optimizers must be positioned so that they maintain a 25 mm clearance distance between the power optimizer and other surfaces to allow for heat dissipation.

**Note:** Ensure the junction box of each PV module is near the side of rail where the optimisers are mounted.

**Note:** Ensure clearance between power optimizers and PV module junction boxes.

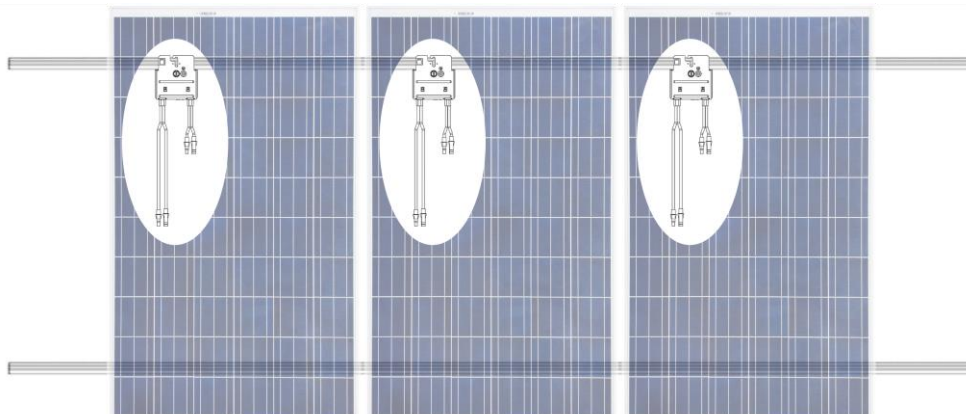

- Attach each power optimizer to the mounting rail using the Z-module assembly provided in the BOS kit. See figure below. Apply a tightening torque of 9.5 Nm.



Z-module assembly

**Note:** It is recommended that the power optimizers be placed face down to ensure clearance between the back of modules and power optimizers. See figure below.

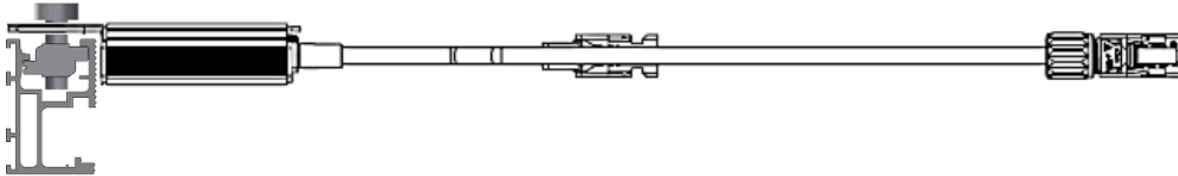

**Note: Figure is not to scale.**

- Verify that each power optimizer is securely attached to the rail.
- Record power optimizer serial numbers and locations. This can be achieved through the use of a paper template or SolarEdge smartphone application. Refer to SolarEdge supplied documentation for more information.

#### POWER OPTIMIZER WIRING PROCEDURE

**⚠ Warning:** Use insulated tools and wear PPE when performing wiring to prevent the risk of electric shock. It is suggested that modules be covered with an opaque material during wiring to reduce the voltage generated by the string.

PV Module and power optimizer DC plug connectors are connected as follows:

Firmly push positive (+) plug into negative (-) plug until an audible “click” is heard, and then try to pull plugs apart. Incorrectly connected plugs will come apart whilst correctly connected plugs will not come apart unless the locking latches on either side of the positive (+) plug are depressed using an unlocking tool whilst plugs are pulled apart.

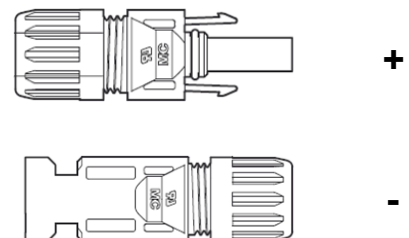

**Note:** Pull on plugs, do not pull on wiring.

**⚠ Warning:** Do not connect / disconnect DC connectors or wiring while under load.

**⚠ Warning:** Only connectors of the same make and model may be connected together.

The following procedure should be adhered to whilst wiring power optimizer strings to prevent the risk of electric shock or inadvertent short circuiting of live cables whilst wiring the Rooftop DC Isolator:

- Two extension leads per string should be constructed using the DC extension cable provided in the BOS Kit. One should be short to connect from the first power optimizer in the string to the DC isolator. The other should be sufficiently long to plug the end power optimizer in the string to the DC isolator (see the example schematic below).

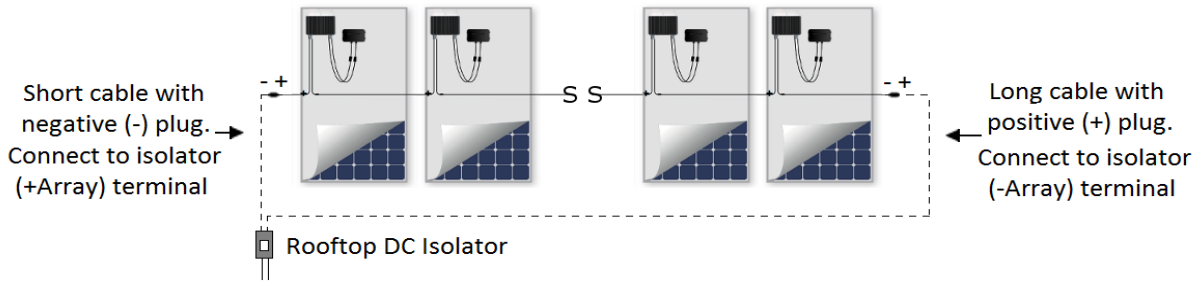

2. Ensure the Rooftop DC Isolator is in the OFF position, strip 12 mm of insulation from the end of each extension lead and connect the two extension leads to the Rooftop DC Isolator terminals. The Rooftop DC Isolator should be wired in a consistent manner. Refer to “DC Isolator Wiring” on page 41.
3. Connect the first power optimizer’s positive output (+) cable plug to the Rooftop DC Isolator extension cable negative (-) plug. See figure below for power optimizer cable plug illustration.

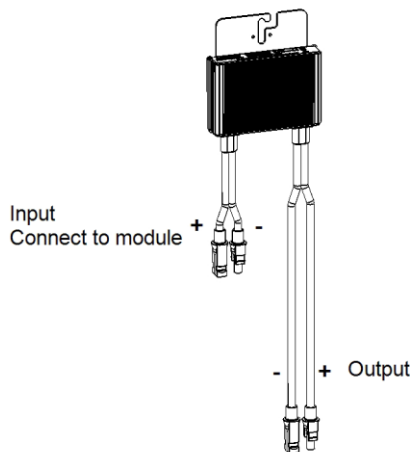

**Note:** Image is for illustration purposes only. Refer to the label on the product to identify the plus and minus input and output connectors.

4. Connect each power optimizer’s negative output (-) cable to the following power optimizer’s positive output (+) cable.
5. Connect the last power optimizer’s negative output (-) cable to the Rooftop DC Isolator extension cable positive (+) plug.
6. Connect the first power optimizer’s input connectors to the first module’s connectors.
7. Repeat Step 6 for each module and power optimizer in the string.
8. Verify proper power optimizer connection by measuring the voltage of each string individually.

**Note:** Each power optimizer in the string will output a safe voltage of 1 V ( $\pm 0.1$  V). For example: 9 power optimizers connected in a single string should output a safe voltage of 9 V ( $\pm 0.9$  V).

**Note:** Ensure the modules are exposed to sunlight during this process; otherwise, the power optimizers may not be powered.

9. Repeat Steps 1 - 8 for each string in the PV array.
10. Your PV array wiring is now complete.

**Note:** The Rooftop DC Isolator should still be in the OFF position at the completion of this stage of the installation. It should not be turned ON until the correct stage of commissioning. Refer to “Solar Isolation Device(s) Test – Rooftop DC Isolator(s)” on page 63.

---

## POWER OPTIMISERS (TIGO)

---

**⚠ Warning:** Do not install TS4s if they have been physically damaged or with damaged or substandard wiring or connectors.

**⚠ Warning:** Do not connect or disconnect TS4s under load. Do not connect / disconnect DC connectors or wiring while under load.

**⚠ Warning:** Only connectors of the same make and model may be connected together.

**⚠ Warning:** When used as a PVRSS (Photovoltaic Rapid Shutdown System) solution, all solar modules in the array must be equipped with TS4-A-O/S and TAP PVRSE with a permanent or temporary (for commissioning) CCA. Rapid shutdown is initiated upon AC power loss that stops power to the TAP.

### SYSTEM LAYOUT -

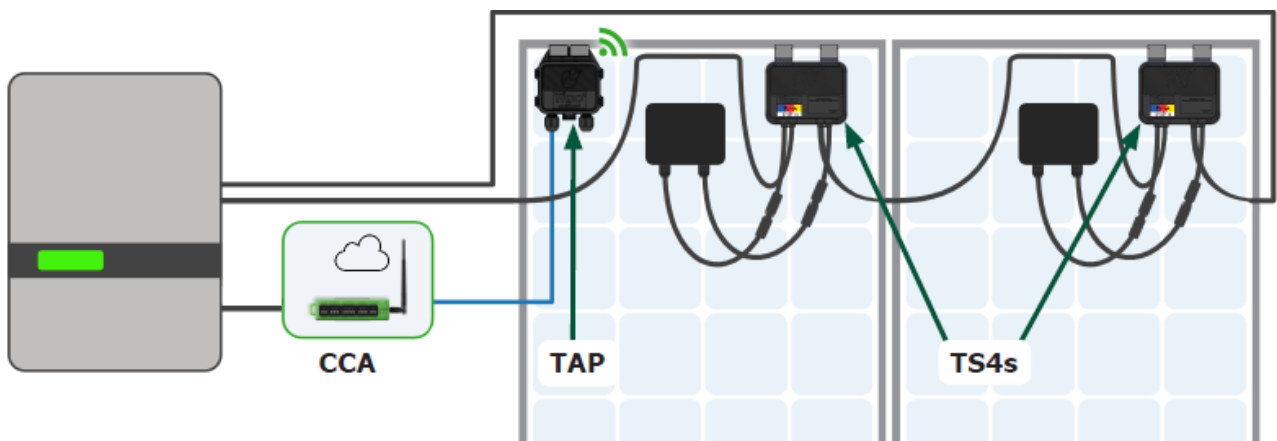

- The Cloud Connect Advanced (CCA) data logger/gateway connects to the cloud via Ethernet or WiFi and to other devices via Modbus.
- The CCA has a wired connection to the Tigo Access Point (TAP).
- The TAP communicates wirelessly with TS4-A-O/S/M MLPE via a mesh network.

## TS4 MOUNTING OPTIONS

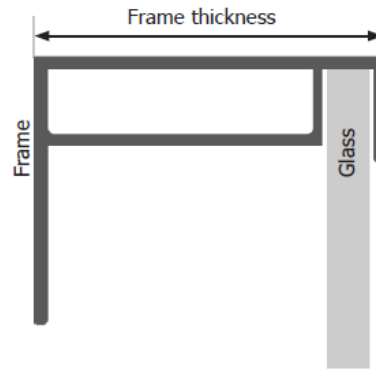
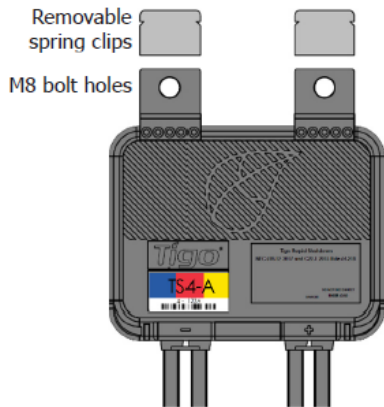

If frame thickness is  $\leq 35\text{mm}$  (1.4in), install with the TS4 label facing the PV module.

## INSTALLING TS4 OPTIMISERS

**⚠ Warning:** All PVRSE (Photovoltaic Rapid Shutdown Equipment) components must be installed and maintained by qualified personnel in accordance with applicable electrical codes and instructions in the TS4-A with CCA and TAP Installation Manual.

**⚠ Warning:** Improper installation may cause damage not covered by the warranty.

1. Save the QR/barcode sticker on a sitemap or string list.
2. Attach the TS4 to the top of the PV module frame. If the frame thickness is  $\leq 35\text{mm}$  (1.4in), install with the TS4 label facing the PV module.
3. Connect the short input cables to the PV module. Connect the long output cables to the adjacent TS4.

**⚠ Warning:** Always assume that TS4s are in an ON state.

**⚠ Warning:** Ensure cable glands face down and cannot collect moisture.

**⚠ Warning:** Disconnect TS4s from the array string before disconnecting from a PV module.

**⚠ Warning:** Always connect short input cables before connecting long output cables. Failure to do so may void warranty.

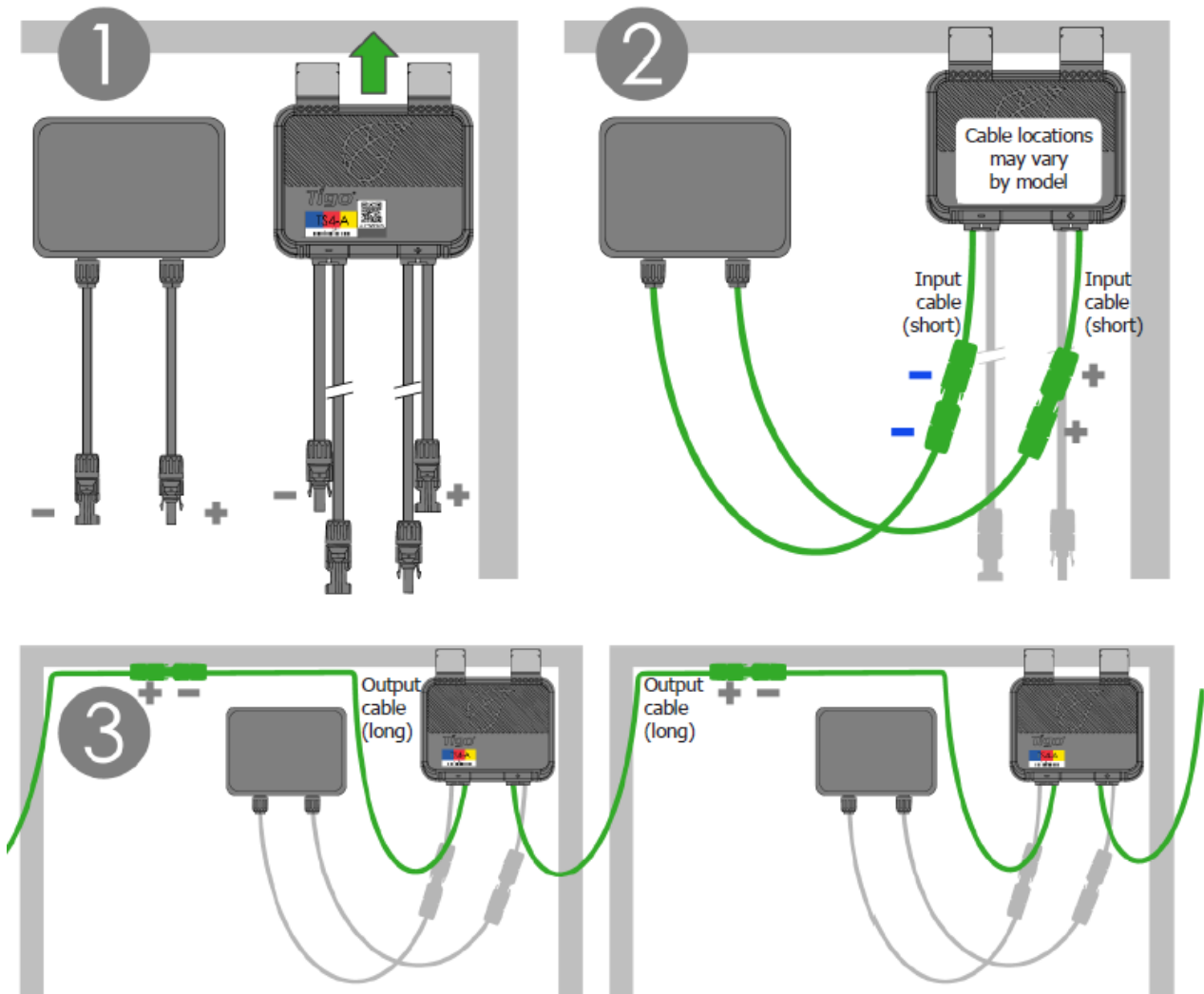

### TAP INSTALLATION

One TAP can communicate with up to 300 TS4s.

⚠ **Warning:** Ensure the TAP is within 10m of a TS4.

⚠ **Warning:** Ensure the cable glands of TAP face down and cannot collect moisture.

⚠ **Warning:** Make all connections to the CCA before powering on the CCA.

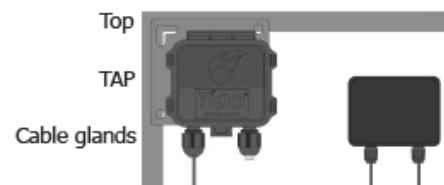

Locate the TAP centrally in an array.

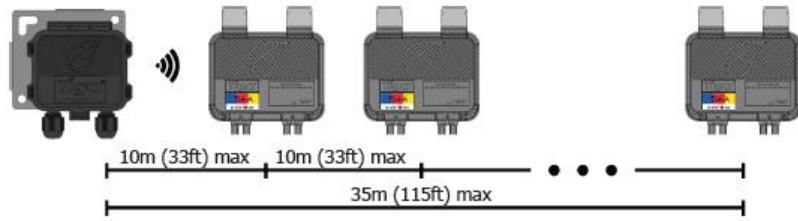
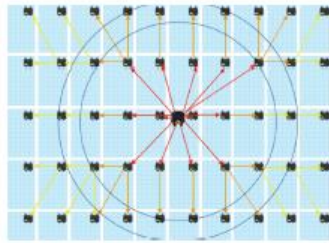

Connect the TAP and CCA using 4-wire or CAT5/6 cables.



### INSTALL A CCA

**Warning:** The CCA must be on the same AC branch as the Inverter.

**Warning:** Rapid shutdown occurs when an AC disconnect (Inverter or switch) disconnects power to the CCA/TAP.

**Warning:** Make all connections to TAPs before powering CCAs.

1. Mount the CCA with IP66 (Outdoors) enclosure.
2. Connect TAP wires to the CCA gateway port.
3. Connect a TIGO or 3<sup>rd</sup> party power supply with 24VDC output

**TESTING/COMMISSIONING** – Download the Tigo Energy Intelligence mobile app to test and commission all TS4/TAP/CCA components. To remove a CCA post commissioning contact Tigo support.

Use the following QR Codes to access further information and resources:

### Resources





---

# PV MODULES

---

## PV MODULES

PV modules generate electricity as soon as they are exposed to sunlight and as such they can represent a danger. All warnings in this manual must be observed when handling solar modules to avoid the risk of fire, sparking and/or electrocution.

If modules are connected in series (summing voltage) the combined voltage must not exceed the inverter's maximum input voltage rating. For the maximum number of series connected modules permissible, refer to the relevant wiring diagram in this document for the inverter model installed.

The Solahart mounting system requires the use of modules of equal thickness for correct clamping.

**Note:** Ensure only modules of the same type (model & thickness) are clamped side-by-side and electrically connected.

## MODULE HANDLING

Modules should be handled with care and protected from damage at all times. All warnings and instructions on the packaging should be observed. Follow these guidelines when unpacking, transporting or storing the modules:

- Store modules in a dry and properly ventilated room. The packaging is not weatherproof.
- Leave the PV modules in the original packaging until installation.
- Inspect the packaging and modules prior to installation. Report any damage to Solahart immediately.
- Note module serial numbers before installation and record serial numbers in the system documentation.
- Do not stack, step on, or drop modules. Do not allow any subject to fall on modules.
- Carry modules with the short side vertical using both hands and do not use the junction box or connection cables as a grip.
- Do not subject modules or backsheets to loads or stresses. Max torsion 10 mm/m.
- Do not use modules that have been dropped.
- Keep all electrical contacts clean and dry.
- Do not modify the module or drill additional holes in any part of the module. This will void the product warranty.
- Do not install modules in windy or wet weather.

**⚠ Warning:** Do not use modules which are broken or damaged. If the module front glass is broken or laminate back sheet is damaged in any way, hazardous voltages may be exposed.

## STRING WIRING PROCEDURE

**Note:** If you have completed the "Power Optimizer Wiring Procedure" on page 43, proceed to "Earthing" on page 50.

**⚠ Warning:** Use dry, insulated tools and wear PPE when performing wiring to prevent the risk of electric shock. It is suggested that modules be covered with an opaque material during wiring to reduce the voltage generated by the string.

PV Modules can only be connected with DC plug connectors as follows:

Firmly push positive (+) plug into negative (-) plug until an audible "click" is heard, and then try to pull plugs apart. Incorrectly connected plugs will come apart whilst correctly connected plugs will not come apart unless the locking latches on either side of the positive (+) plug are depressed using an unlocking tool whilst plugs are pulled apart.

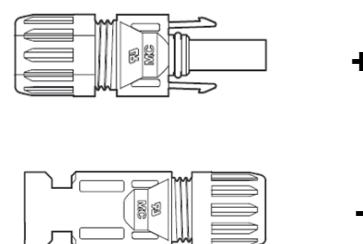

**Note:** Pull on plugs, do not pull on wiring.

**Note:** Ensure that the cabling is not under stress.

**⚠ Warning:** Do not connect / disconnect DC connectors or wiring while under load.

**⚠ Warning:** Do not connect any exposed cable ends. Do not touch "+" and "-" poles at the same time.

**⚠ Warning:** Only connectors of the same make and model may be connected together.

Use minimum 4 mm<sup>2</sup> copper wires insulated for minimum 90°C for field connections.

The following procedure should be adhered to whilst wiring module strings to prevent the risk of electric shock or inadvertent short circuiting of live cables whilst wiring the Rooftop DC Isolator:

1. Two extension leads per string should be constructed using the DC extension cable provided in the BOS Kit. One should be short to connect from the first module in the string to the DC isolator. The other should be sufficiently long to plug the end module in the string to the DC isolator (see the example schematic below).
2. Ensure the Rooftop DC Isolator is in the OFF position, strip 12 mm of insulation from the end of each extension lead and connect the two extension leads to the Rooftop DC Isolator terminals. The Rooftop DC Isolator should be wired in a consistent manner. Refer to “DC Isolator Wiring” on page 41.
3. Connect the first module positive (+) cable plug to the Rooftop DC Isolator extension cable negative (-) plug.
4. Connect each module’s negative (-) cable to the following module’s positive (+) cable as modules are being installed until the halfway point is reached i.e. fourth module in an eight module string.
5. Install and connect the remaining modules, but do not make the halfway connection, i.e. in an eight module string do not connect the fourth module negative (-) cable to the fifth module positive (+) cable (refer to wiring diagram below). These two cables will be connected at the end of this procedure.
6. Connect the last module’s negative (-) cable to the Rooftop DC Isolator extension cable positive (+) plug.
7. Complete the circuit by connecting the two string halves together by connecting the positive (+) and negative (-) cables of the two modules left previously disconnected in step 5.

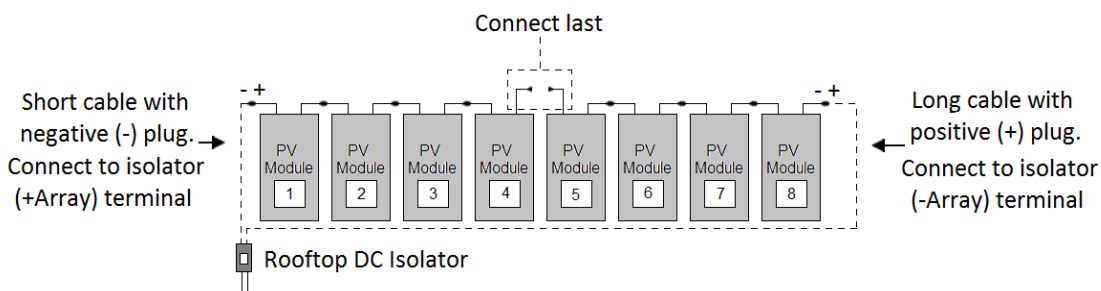

**Note:** Modules may be connected in a different order provided that all modules in a string are connected in series.

**Note:** The Rooftop DC Isolator should still be in the OFF position at the completion of this stage of the installation. It should not be turned ON until the correct stage of commissioning. Refer to “Solar Isolation Device(s) Test – Rooftop DC Isolator(s)” on page 63.

**⚠ Caution:** Ensure all the plug connections are secured away from any water carrying surfaces.

**EARTHING**

All modules and rails must be earthed. Refer to “Earthing Arrangements – All Systems” on page 13. Earthing connections must be made by a suitably qualified person according to the relevant standards outlined on page 4. It is also recommended that a reliable lightning protection system be installed.

Stainless steel serrated washers must be used so the rail anodising is pierced, providing good electrical continuity. Stainless steel nuts, bolts and washers must be used and all ferrous metal in conductive connections should be specially treated to prevent corrosion (i.e. by spray painting or coating with a galvanising paint). Refer also to “Earthing Arrangements – All Systems” on page 13.

**Universal Clamp with earthing plate**

To earth modules and rails, use universal clamps with earthing plates when mounting modules. Install the clamps in accordance with the following instructions. When installed correctly, earthing plates will provide earth bond continuity between rails and modules whilst allowing removal of a module without affecting the earthing integrity of other components in the system. The rails must then be earthed by connecting a suitably sized earth wire. Refer to “Earthing Arrangements – All Systems” on page 13.

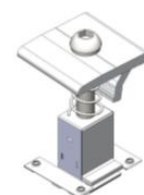

Universal clamps with Earthing Plate

**⚠ Warning:** If rails are not of a continuous length, or rail splices do not provide satisfactory earth continuity, earth bond jumper cables must be used across rails or rail splices or each section of rail must have a separate earth wire connection.

**⚠ Warning:** All inverters supplied by Solahart are transformerless, functional earthing of PV array is strictly prohibited. Refer to AS/NZS 5033 for details.

## MODULE MOUNTING

### Fastening the modules to the mounting structure

Each module must be securely fixed to the mounting structure at a minimum of four points. The distance between the end clamp and the end of the rail should be a minimum of 25 mm. The mounting clamps must be fastened so the clamp lies completely within the range shown below for each type of module.

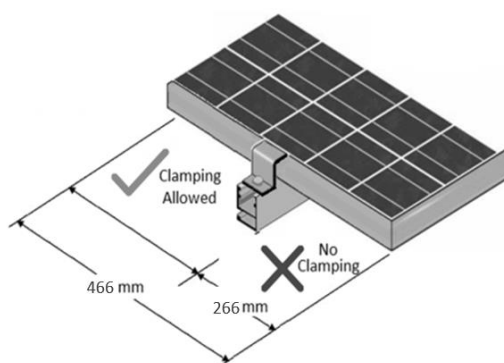

**Note: Figure is not to scale**

For all installations, apart from the exceptions listed in the table below, the allowable clamping zone is **266 – 466 mm** from the edge of the panel.

For Solahart440BRB1 in Wind Region - A: Flush Mount Systems (tin/tile roof interface)

Terrain Category	Roof Angle	Building Height	Clamping Zone (mm)	Building Height	Clamping Zone (mm)
TC 2 (open terrain)	$0^\circ \leq \alpha \leq 10^\circ$	<5m	0 - 466	5m < H < 10m	150 - 466
TC 2 (open terrain)	$10^\circ \leq \alpha \leq 20^\circ$				
TC 2 (open terrain)	$20^\circ \leq \alpha \leq 30^\circ$				
TC 2.5 (open terrain)	$0^\circ \leq \alpha \leq 10^\circ$	<5m	0 - 466	5m < H < 10m	0 - 466
TC 2.5 (open terrain)	$10^\circ \leq \alpha \leq 20^\circ$				
TC 2.5 (open terrain)	$20^\circ \leq \alpha \leq 30^\circ$				
TC 3 (nearby obstruction)	$0^\circ \leq \alpha \leq 10^\circ$	<5m	0 - 466	5m < H < 10m	0 - 466
TC 3 (nearby obstruction)	$10^\circ \leq \alpha \leq 20^\circ$				
TC 3 (nearby obstruction)	$20^\circ \leq \alpha \leq 30^\circ$				

**⚠ Caution:** Ensure the clamps are not in contact with the front glass of the PV modules.

**⚠ Caution:** Ensure the junction box does not touch the structure under the panel.

**⚠ Caution:** PV modules can bend under load. Ensure there is no sharp object installed near the back side of the PV modules.

- **⚠ Caution:** Ensure all the drainage holes on module frame are not covered.
- **⚠ Caution:** Ensure all modules are secured during installation.

### Black Universal Clamps

Black Universal Clamps with built-in earthing plates suit PV modules of thickness between 30 mm and 46 mm and can be used as either mid clamps or end clamps.

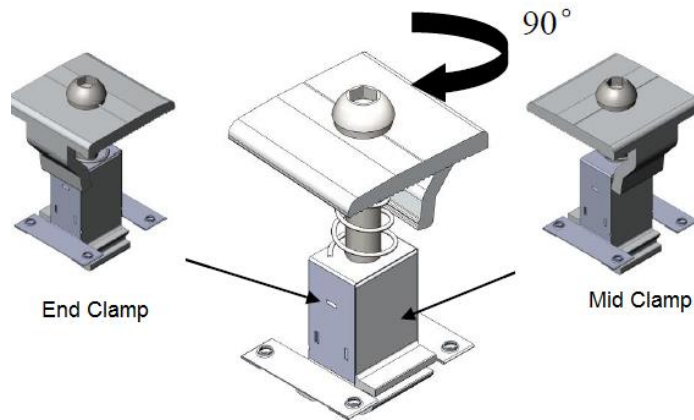

Twisting the head of Universal Clamp changes the functionality from end clamp to mid clamp.

### Inserting the clamps

The universal clamp can be installed by inclining it to engage the channel on its lower part with the lower feature of the rail, and press down the universal clamp towards the other side to engage the channel on its upper part with the upper feature of the rail as shown in the figure below.

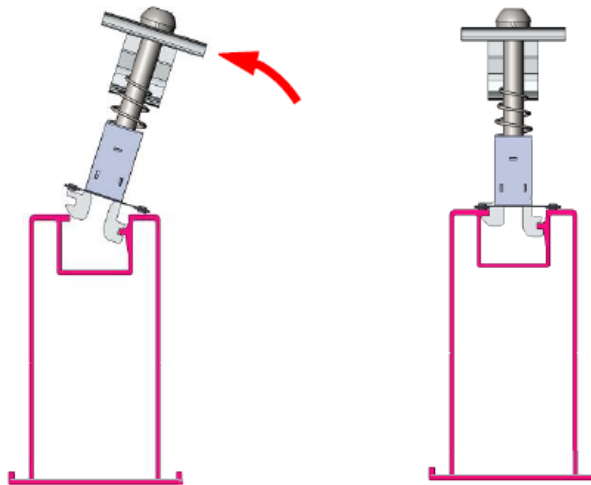

**Note:** before installing, ensure the Allen head bolt thread does not project through the lower side of the module.

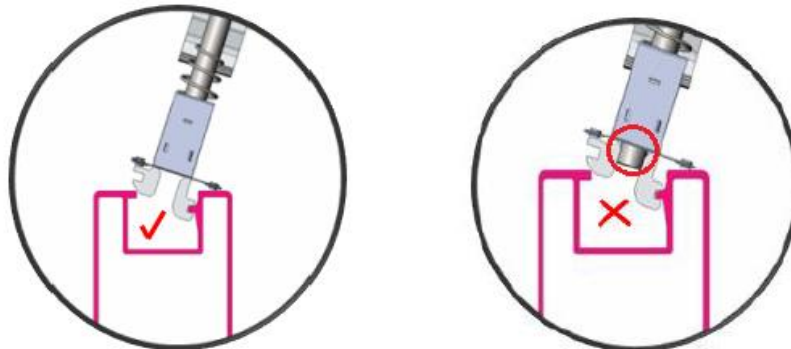

### Module Mounting Procedure

<p>1. When using as end clamp, slide the universal clamp to the position to be fastened. Ensure there is at least 25 mm from the rail end. Then slightly slide the PV Module frame onto the earthing plate of universal clamp. Make sure the frame of PV Module is fully in contact with the universal clamp. Ensure that the end clamps are tight against the module. Then tighten the universal clamp bolt to 13-14 Nm.</p>	
<p>2. Inserting the clamps. Ensure the frame of PV module is fully in contact with the universal clamp.</p>	
<p>3. Slightly slide the next PV Module into the other side of universal clamp, ensure the frame of PV Module is closely in contact with the universal clamp. Visually check to ensure the universal clamp and PV module are properly positioned. Then tighten the universal clamp bolt to 18-20 Nm.</p> <p>Ensure both module frame edges are located on top of the protrusions of the earthing plate.</p> <p>Repeat steps 2 and 3 for each remaining module in the row.</p>	
<p>4. Place a universal clamp into the end of each rail. Ensure that the end clamps are tight against the module and are at least 25 mm from the rail ends.</p> <p>Ensure the frame of module is located on top of the protrusions of the earthing plate. Tighten the universal clamp bolts to 13-14 Nm.</p>	
<p>5. Repeat steps 1 - 4 for each row of modules.</p> <p><b>Note:</b> Universal clamps may be temporarily placed between rows to ensure 20 mm uniform spacing between rows.</p>	

Module installation is now complete.

# INVERTER

For inverter installation instructions and warranty exclusions refer to the documents supplied with the inverter. The following points must also be observed when installing the inverter:

**⚠ Warning:** Inverters have masses between 7 kg and 30 kg. Proper safe handling procedures must be employed when installing or handling these inverters.

- Inverters must be sheltered from direct sunlight and other sources of heat.
- Inverters must be installed in a well-ventilated place so as to allow good circulation of air around the unit. Avoid places where air cannot circulate freely around the unit.
- The inverter must not be installed in a location accessible to children.
- The mounting structure must be capable of supporting the inverter weight.
- If the inverter is to be mounted on a combustible surface such as wood, a heat resistant backing (such as a fibre cement board) must be installed behind the inverter. Backing must extend a minimum of 20 mm past all edges and sides of the inverter.
- Inverter mounting clearances and requirements outlined in the relevant inverter documentation must be adhered to. Ignoring recommended mounting instructions can cause permanent damage to the inverter from water ingress and can reduce inverter efficiency due to inadequate heat dissipation.
- Sealing plugs provided with the inverter must be inserted into any unused string inputs to maintain the inverter's IP rating. Verify the presence of watertight rubber cap seals on DC input connectors and install them should they be absent.
- When installing an inverter with a StorEdge Connection Unit, do not install fuses if a battery is not installed. Leave all fuses in their original packaging behind the plastic cover inside the StorEdge Connection Unit, clear from all electrical wires and components.

## MULTI-CONTACT DC CONNECTIONS

Multi-Contact Safety Locking Clips must be installed over the negative connectors of all Multi-Contact DC connections at the inverter. The purpose of these devices is to prevent accidental disconnection of live DC at the inverter. When the Safety Locking Clip is in place, a custom tool is required to separate the connectors.

Multi-Contact (MC) Positive (+) Connector: PV-KBT4	Multi-Contact (MC) Negative (-) Connector: PV-KST4	Multi-Contact (MC) Safety Locking Clip: PV-SSH4
		

## FIMER INVERTERS

### AC Cable Sizing Table

Inverter AC cabling must be sized and installed in accordance with AS/NZS 3000, AS/NZS 3008 and any local applicable codes. Cables selected must have an appropriate current carrying capacity for the maximum fault current output of the inverter, and the Inverter AC isolator, taking into consideration relevant de-rating factors.

**For cable sizing details please refer to the Inverter installation manual as per the Inverter list on page 65.** For FIMER inverters, refer to FIMER Quick Installation Guide for AC Cable sizing.

- If the installation requires different cabling or has installation conditions different to those specified in the installation manuals or guides, the installer must undertake appropriate calculations to ensure the cabling is correctly sized.
- The installer must determine the current carrying capacity in accordance with AS/NZS 3008.1.1.

### Earth Fault Alarms

The installation of an earth fault alarm compliant with AS/NZS 5033 requirements is mandatory for all arrays. For earth fault management please refer to the respective Inverter installation manual as per the inverter list on page 65.

## GOODWE INVERTERS

For inverter installation instructions and warranty exclusions refer to the Instructions for Quick Installation supplied with the inverter.

### AC CABLE SIZING TABLE

Inverter AC cabling must be sized and installed in accordance with AS/NZS 3000, AS/NZS 3008.1.1 and any local applicable codes. Cables selected must have an appropriate current carrying capacity for the maximum current output of the inverter, and the Inverter AC isolator, taking into consideration relevant de-rating factors. For the nominal trip current of the AC breaker, refer to the “Wiring Diagram” beginning on page 6.

Inverter Model	Maximum AC Output Current (A)	Inverter Model	Maximum AC Output Current (A)
GW1500-XS-11	7.2	GW6000-ES-20	27.3
GW2500-XS-11	12.0	GW5000N-EH	21.7/24**
GW3000-DNS-30	14.4	GW6000N-EH	26.1/28.7**
GW5000-DNS-30	24.0	GEH8.6-1U-10	39.0
GW6000-DNS-30	28.8	GEH10-1U-10	43.5
GW5000-MS-30	24.0	SE3000H-xxxxxxxxx*	14.0
GW8500-MS-30	40.7	SE5000H-xxxxxxxxx*	23.0
GW10K-MS-30	43.5	SE6000H-xxxxxxxxx*	27.5
GW5000-ES-20	22.7	SE8250H-xxxxxxxxx*	37.5
UNO-DM-3.3-TL-SBQ	14.5	SE10000H-xxxxxxxxx*	45.5
UNO-DM-4.0-TL-SBQ	22.0	UNO-DM-5.0-TL-SBQ	24.0

\* This model may have suffixes indicating different options and functionality.

\*\* For these inverter models, phase ratings on three phase homes must be checked for circuit breaker ratings larger than the inverter’s Maximum AC Fault Current.

Inverter AC cabling must have a voltage drop or rise less than 1% in accordance with AS/NZS 5033. For common PVC/PVC cable types operating at 75°C on a 230 V single-phase circuit, the following table provides for a voltage variation of less than 1%.

**For cable sizing details please refer to the Inverter installation manual as per the Inverter list on page 65.**

**Note:** If the installation requires different cabling or has installation conditions different to those specified above, the installer must undertake appropriate calculations to ensure the cabling is correctly chosen and sized.

**Earth Fault Alarms**

The installation of an earth fault alarm compliant with AS/NZS 5033 requirements is mandatory for all arrays. For earth fault management please refer to the respective Inverter installation manual as per the inverter list on page 65.

**SOLAREEDGE INVERTERS**

For inverter installation instructions and warranty exclusions refer to the inverter installation manual supplied with the inverter.

**Earth Fault Alarms**

The installation of an earth fault alarm compliant with AS/NZS 5033 requirements is mandatory for all arrays. For earth fault management please refer to the respective Inverter installation manual as per the inverter list on page 65.

**AC Cable Sizing table**

Inverter AC cabling must be sized and installed in accordance with AS/NZS 3000, AS/NZS 3008 and any local applicable codes. Cables selected must have an appropriate current carrying capacity for the maximum fault current output of the inverter, and the Inverter AC isolator, taking into consideration relevant de-rating factors.

**For cable sizing details please refer to the Inverter installation manual as per the Inverter list on page 65.**



---

## METER (SOLAREGE ONLY)

---





**Note:** The meter is an optional accessory for use in battery systems and for zero export requirements.





For more information on Meter installation and commissioning please refer to the SolarEdge Inverter Installation manual and Solahart Quick Start Guide. Installation manual reference is available in the Inverter list on page 65.





# LABELLING

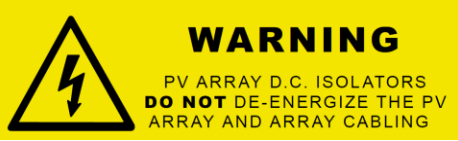

This information is supplied here as a guide only. Additional labels may be required depending upon the installation and local requirements. Labels must be constructed to AS 1319 and installed according to AS 4777.1, AS/NZS 5033 and any local regulations. Refer to aforementioned standards for more information.

The purpose of labelling is to clearly indicate that the electrical installation has multiple supplies and which circuits are affected by these supplies. Labelling also identifies the components that isolate the various supplies. Labels relating to the PV system must be placed on the switchboard to which the PV system is directly connected. If the PV system is directly connected to a distribution board, additional labels must also be placed on the main switchboard and all intermediate distribution boards. Installations using the DC Isolators must use the DC Isolator labels however installations using Disconnection Points will require extra set of labels for disconnection points, warnings for ceiling access and cables etc. The following table details labels that are supplied in Solahart PV Systems.

Label	Colour	Location
	<p style="text-align: center;">Black text on yellow background</p>	<p style="text-align: center;">Prominent position on the switchboard where the inverter is connected to</p>
	<p style="text-align: center;">White text on red background</p>	<p style="text-align: center;">Adjacent to main switch to grid supply</p>
	<p style="text-align: center;">White text on red background</p>	<p style="text-align: center;">Adjacent to the isolator for normal supply to the distribution board (applicable only when the inverter is connected to a distribution board)</p>
	<p style="text-align: center;">White text on red background</p>	<p style="text-align: center;">Solar inverter main switch if inverter is located adjacent to switchboard</p>
 <p style="text-align: center;">Solar plant location to be entered by installer</p>	<p style="text-align: center;">White text on red background</p>	<p style="text-align: center;">OR</p> <p style="text-align: center;">Solar inverter main switch if inverter is not located adjacent to main switchboard</p>

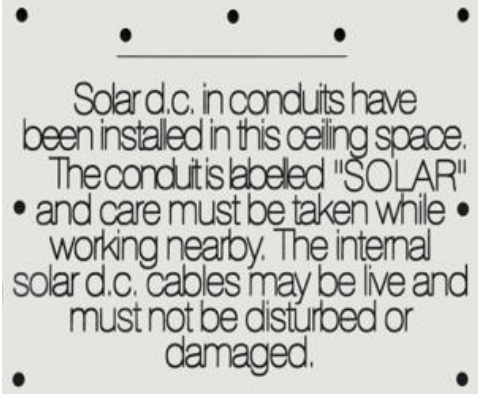
Label	Colour	Location
<div style="border: 1px solid black; padding: 5px; background-color: red; color: white; text-align: center;"> <p><b>SOLAR ARRAY ON ROOF</b></p> <p>Open circuit voltage ____ V</p> <p>Short circuit current ____ A</p> </div> <p style="text-align: center;">Values to be entered by installer</p> <p><b>SOLAREEDGE SYSTEMS ONLY:</b></p> <p>Open circuit voltage: Inverter maximum DC operating voltage</p> <p>Short circuit current: Inverter maximum input current</p>	<p>White text on red background</p>	<p>Prominent position adjacent to meter box and building's main switchboard</p>
	<p>Reflective white text on reflective green background</p>	<p>Prominent position on or adjacent to the meter box (only for isolator type installation)</p> <div style="border: 1px solid black; width: 40px; height: 30px; margin: 10px auto; text-align: center; line-height: 30px;">OR</div>
	<p>Reflective white text on reflective green background</p>	<p>Prominent position on or adjacent to the meter box (only for disconnection point type installation)</p>
<div style="border: 1px solid black; padding: 5px; width: fit-content; margin: 0 auto;"> <p>PV ARRAY D.C. ISOLATOR</p> </div>	<p>Black text on white background</p>	<p>Rooftop and inverter Solar DC isolators</p>
<div style="border: 1px solid black; width: 40px; height: 40px; margin: 0 auto; display: flex; align-items: center; justify-content: center;">  </div>	<p>Black text on white background</p>	<p>Next to "PV ARRAY D.C. ISOLATOR" label, pointing to the location of Inverter built-in DC Isolator (if Applicable)</p>
<div style="border: 1px solid black; padding: 5px; width: fit-content; margin: 0 auto;"> <p>INVERTER A.C. ISOLATOR</p> </div>	<p>Black text on white background</p>	<p>Inverter AC isolator</p>
<div style="border: 1px solid black; padding: 5px; background-color: yellow;"> <div style="display: flex; align-items: center;">  <div> <p><b>WARNING</b></p> <p>MULTIPLE SUPPLIES</p> <p>ISOLATE INVERTER SUPPLY AT DISTRIBUTION SWITCHBOARDS LOCATION: _____</p> </div> </div> </div> <p style="text-align: center;">Distribution board number to be entered by installer i.e. DB1</p>	<p>Black text on yellow background</p>	<p>Main switchboard (applicable when the inverter is connected to a distribution board)</p>

Label	Colour	Location
 <p><b>PV OPERATING PROCEDURE TO SHUT DOWN:</b>            Turn OFF Main Switch (Inverter Supply) at A.C. Switchboard and Inverter A.C. Isolator at Inverter (where installed) Then turn off the PV Array D.C. isolator.  <b>TO START UP:</b>            Turn on the PV Array D.C. isolator Then turn on the inverter A.C. isolator (where installed) and the Main Switch (Inverter Supply)  <b>NOTE: There may be more than one D.C. Isolator</b>  <b>FOR SERVICE PHONE: 1800 638 011</b></p>	<p>Black and white</p>	<p>Prominent position adjacent to the inverter</p>
	<p>Black text on yellow background</p>	<p>Added below the shutdown sign (Solahart PV Operating Procedure)</p>
	<p>Black text on yellow background</p>	<p>Prominent position adjacent to the inverter (where multiple isolators/disconnection devices are used)</p>
	<p>Black text on yellow background</p>	<p>Prominent position adjacent to the inverter (where multiple isolators/disconnection devices are used)</p>
	<p>Black text on yellow background</p>	<p>Signs for junction boxes containing PV d.c. cable terminations (only for disconnection point type installation)</p>
	<p>Black text on yellow background</p>	<p>Attached to the PV module or structure within 300mm of the disconnection point</p>
	<p>Black and white</p>	<p>Adjacent to the access point (for disconnection point type installation)</p>

Label	Colour	Location
	<p>Black text on yellow background</p>	<p>Added on the ceiling access sign</p>
	<p>Black text on yellow background</p>	<p>On the cable within 100mm of the disconnection point</p>

S

---

# COMMISSIONING

---

Systems must be commissioned according to AS/NZS 5033. Commissioning tests are required to ensure that the system complies with the aforementioned standard. Commissioning information is provided here as a guide only and it is the installer's responsibility to ensure that the requirements of AS/NZS 5033 are met. A copy of the relevant commissioning documents must be provided to the owner and a copy kept by the installer.

Before starting any of the tests below, ensure that:

- The Main Switch (Inverter Supply) at the AC switchboard is in the OFF position.
- The Inverter AC Isolator at the inverter is in the OFF position (if installed).
- The Inverter DC Isolator(s) at the inverter are in the OFF position.
- The Rooftop DC Isolator(s) are in the OFF position.

**⚠ Warning:** Dangerous DC voltages may be present during the following commissioning procedure. Appropriate personal protective equipment should be used.

## VERIFICATION OF MODULE AND RAIL EARTH RESISTANCE

This test is performed to ensure modules, rails and other mounting components are correctly earthed.

8. Using a multimeter set on the ohms scale, measure between each module and the system earth wire. Earth resistance must be 0.5  $\Omega$  or less.
9. Using a multimeter set on the ohms scale, measure between each rail and the system earth wire. Earth resistance must be 0.5  $\Omega$  or less.
10. Using a multimeter set on the ohms scale, measure between each mounting component and the system earth wire. Earth resistance must be 0.5  $\Omega$  or less.

## STRING OPEN CIRCUIT VOLTAGE ( $V_{oc}$ ) TEST

This test is performed to ensure the wiring polarity and continuity of the PV array is correct. Measurements should be made under stable irradiance conditions close to solar noon if possible. Where multiple strings are installed, this test procedure must be repeated for each string.

The voltage measurement obtained should be the number of modules in the string multiplied by the  $V_{oc}$  of one module. For example: For a string with 9 X SOLAHART440BRB2 modules: String  $V_{oc} = 9 \times 39 \text{ V DC} \approx 351 \text{ V DC}$ . Refer to "Voltage Tables for GoodWe and FIMER Systems" or "Voltage Tables for SolarEdge Systems" on page 11.

1. Ensure that the Inverter AC Isolator(s) are in the OFF position.
2. Ensure that the Inverter DC Isolator(s) are in the OFF position.
3. Ensure that the Rooftop DC Isolator(s) are in the OFF position.
4. Using a multimeter set on the DC voltage scale, measure between the string positive and negative terminals at the module side of the string Rooftop DC Isolator and compare the value obtained with the table below. For SolarEdge systems see note below.

**Note (SolarEdge systems only):** Each power optimizer in a string will output a voltage of 1 V ( $\pm 0.1 \text{ V}$ ). For example: 9 power optimizers connected in a string should output a voltage of 9 V ( $\pm 0.9 \text{ V}$ ).

5. Repeat for each string.

The open-circuit voltage ( $V_{oc}$ ) of every string must be measured before switching on the inverter and must be within 5% of the calculated value. If readings are outside the calculated value by more than  $\pm 5\%$ , then connections must be verified for polarity, continuity and possible faults and repaired where necessary. Once verification has been satisfactorily completed, strings may then be connected to the inverter.

**SOLAR ISOLATION DEVICE(S) TEST – ROOFTOP DC ISOLATOR(S)**

This test is performed to ensure the Rooftop DC Isolator(s) are isolating the string(s) from the inverter when in the OFF position.

1. Ensure that the Inverter AC Isolator(s) are in the OFF position.
2. Switch all string DC Isolators to the ON position (Rooftop and Inverter DC Isolators).
3. Ensure that the PV system is operating under irradiance conditions greater than 500 W/m<sup>2</sup>.
4. Switch the string Rooftop DC Isolator to the OFF position.
5. Disconnect string positive and negative DC plug connectors from inverter.
6. Using a multimeter set on the DC voltage scale, connect multimeter leads between the disconnected string plugs. Ensure leads are firmly connected. If a DC voltage is present, the Rooftop DC Isolator or system wiring is faulty and will require replacing or repairing.

**Note (SolarEdge systems only):** Each power optimizer in a string will output a voltage of 1 V ( $\pm 0.1$  V). For example: 9 power optimizers connected in a string should output a voltage of 9 V ( $\pm 0.9$  V).

7. Switch the string Rooftop DC Isolator to the ON position. If a DC voltage is not present, the Rooftop DC Isolator or system wiring is faulty and will require replacing or repairing.
8. Switch the string Rooftop DC Isolator to the OFF position.
9. Reconnect string positive and negative DC plug connectors to inverter.
10. Repeat for each string.

**SOLAR ISOLATION DEVICE(S) TEST – INVERTER DC ISOLATOR(S)**

This test is performed to ensure the Inverter DC Isolator(s) are isolating the string(s) from the inverter when in the OFF position.

1. Ensure that the Inverter AC Isolator(s) is in the OFF position.
2. Switch all string DC Isolators to the ON position (Rooftop and Inverter DC Isolators).
3. Ensure that the PV system is operating under irradiance conditions greater than 500 W/m<sup>2</sup>.
4. Switch the string Inverter DC Isolator to the OFF position.
5. Disconnect string positive and negative DC plug connectors from inverter.
6. Using a multimeter set on the DC voltage scale, connect multimeter leads between the disconnected string plugs. Ensure leads are firmly connected. If a DC voltage is present, the Inverter DC Isolator or system wiring is faulty and will require replacing or repairing.

**Note (SolarEdge systems only):** Each power optimizer in a string will output a voltage of 1 V ( $\pm 0.1$  V). For example: 9 power optimizers connected in a string should output a voltage of 9 V ( $\pm 0.9$  V).

7. Switch the string Inverter DC Isolator to the ON position. If a DC voltage is not present, the Inverter DC Isolator or system wiring is faulty and will require replacing or repairing.
8. Switch the string Inverter DC Isolator to the OFF position.
9. Reconnect string positive and negative DC plug connectors to inverter.
10. Repeat for each string.

**INSULATION RESISTANCE TEST**

This test is performed to verify the insulation resistance between the positive DC string wiring and earth and the negative DC string wiring and earth are both greater than or equal to 1 Megaohm (1 MΩ) as required by AS/NZS 5033.

An insulation tester capable of applying test voltages of 500 V and 1000 V is required to perform this test.

**⚠ Warning:** Live voltages of up to 600 VDC will be present during this test. Wear personal protective equipment to prevent the risk of electric shock and treat DC string wiring as if it were live at all times.

**⚠ Warning:** Do not permit any person to touch any part of the array whilst the insulation test is being performed.

1. Ensure that the Inverter AC Isolator is in the OFF position.
2. Switch the Rooftop DC Isolator(s) to the ON position.
3. Switch the Inverter DC Isolator(s) to the OFF position.
4. Disconnect string positive and negative DC plug connectors from inverter.
5. Connect the insulation tester leads between the disconnected positive string plug and earth. Ensure test leads are firmly fixed in position.
6. Select the appropriate test voltage on the insulation tester according to the number of modules in the string (500 V for a string of 6-10 modules; 1000 V for a string of 11-14 modules).
7. Switch the Inverter DC Isolator to the ON position.

**⚠ Warning:** The positive and negative string wiring is now live and will have up to 600 VDC present.

8. Activate insulation tester. The resistance measured must be greater than or equal to 1 MΩ.
9. Switch the Inverter DC Isolator to the OFF position.
10. Connect insulation tester leads between the disconnected negative string plug and earth. Ensure test leads are firmly fixed in position.
11. Switch the Inverter DC Isolator to the ON position.

**⚠ Warning:** The positive and negative string wiring is now live and will have up to 600 VDC present.

12. Activate insulation tester. The resistance measured must be greater than or equal to 1 MΩ.
13. Switch the Inverter DC Isolator to the OFF position.
14. Reconnect string positive and negative DC connectors to the inverter.
15. For the Two String Configuration, repeat this procedure for the second string.

**VERIFICATION OF INVERTER WIRING**

This verification is performed to ensure the inverter is correctly and safely wired. Check the Positive and Negative connectors are fully engaged at the Inverter and any unused inputs have connectors with sealing plugs installed.

**INVERTER COMMISSIONING**

**⚠ Warning:** Do not turn on the inverter until all of the previous commission procedure tests/checks have been satisfactorily completed.

**For information on Inverter commissioning please refer to the respective Inverter Installation manual as per the Inverter table on page 65.**



Following table provides the Indicative string voltage to enable you check that the 'Input Voltage' is within  $\pm 5\%$  of the value for the number of modules in each string:

SOLAHART440BRB2 Modules															
No. of modules	6	7	8	9	10	11	12	13	14	15	16	17	18	19	20
Indicative String $V_{mp}$ *	198	231	264	297	331	364	397	430	463	496	529	562	595	628	661
No. of modules	21	22	23	24											
Indicative String $V_{mp}$ *	694	727	760	793											

\*Values measured at standard test conditions (STC) defined as: irradiance of 1000 W/m<sup>2</sup>, Spectrum AM 1.5, and cell temperature 25°C. Variations from STC values will affect actual  $V_{mp}$  and should be allowed for.

### INVERTER LIST FOR INSTALLATION MANUALS

Part Number	Material Description	Supplier	Installation manual
UNO-DM-3.3-TL-SBQ	INVERTER ABB 3.3KW SCREENLESS DC-ISO	FIMER AUSTRALIA PTY LTD	FIMER UNO-DM-1.2 2.0 3.0 3.3 3.6 4.0 4.6 5.0-TL-PLUS-Q Quick Installation Guide
UNO-DM-5.0-TL-SBQ	INVERTER ABB 5.0KW SCREENLESS DC-ISO	FIMER AUSTRALIA PTY LTD	FIMER UNO-DM-1.2 2.0 3.0 3.3 3.6 4.0 4.6 5.0-TL-PLUS-Q Quick Installation Guide
UNO-DM-6.0-TL-SBQ	INVERTER ABB 6.0KW SCREENLESS DC-ISO	FIMER AUSTRALIA PTY LTD	FIMER UNO-DM-1.2 2.0 3.0 3.3 3.6 4.0 4.6 5.0-TL-PLUS-Q Quick Installation Guide
GEH10-1U-10	GoodWe Hybrid HV 10kW SPH-4MPPT	GOODWE AUSTRALIA PTY LTD	GEH 5-10kW User Manual
GEH8.6-1U-10	GoodWe Hybrid HV 8.6kW SPH-4MPPT	GOODWE AUSTRALIA PTY LTD	GEH 5-10kW User Manual
GW10KL-ET	INVERTER GOODWE 10KW HYBRID	GOODWE AUSTRALIA PTY LTD	GW ET ET User Manual
GW10K-MS-30	INVERTER GOODWE 10KW MS-30	GOODWE AUSTRALIA PTY LTD	GW M20 G3 User Manual
GW1500-XS-11	INVERTER GOODWE XS-11 1.5kW 1-PH DC ISO	GOODWE AUSTRALIA PTY LTD	GW XS User Manual
GW2500-XS-11	INVERTER GOODWE XS-11 2.5kW 1-PH DC ISO	GOODWE AUSTRALIA PTY LTD	GW XS User Manual
GW3000-DNS-30	INVERTER GOODWE 3KW-DNS-30 1PH	GOODWE AUSTRALIA PTY LTD	GW DNS 20 G3 User Manual
GW5000-DNS-30	INVERTER GOODWE 3KW-DNS-30 1PH	GOODWE AUSTRALIA PTY LTD	GW DNS 20 G3 User Manual
GW5000-ES-20	INVERTER GOODWE HYBRID 120A 5kW 1-PH	GOODWE AUSTRALIA PTY LTD	GW ES 3.0-6.0kW G2 User Manual
GW5000-MS-30	INVERTER GOODWE 5KW 1PH 3MPPT MS-30	GOODWE AUSTRALIA PTY LTD	GW M20 G3 User Manual
GW5000-SBP-20	INVERTER GOODWE 5 kW AC Coupled 1-P	GOODWE AUSTRALIA PTY LTD	GW SBP 3.0-6.0kW User Manual
GW5000N-EH	INVERTER GOODWE HYBRID (HV) 5KW 1-PH	GOODWE AUSTRALIA PTY LTD	GW EH User Manual
GW5KL-ET	INVERTER GOODWE 5KW HYBRID	GOODWE AUSTRALIA PTY LTD	GW ET ET User Manual
GW6000-DNS-30	INVERTER GOODWE 3KW-DNS-30 1PH	GOODWE AUSTRALIA PTY LTD	GW DNS 20 G3 User Manual
GW6000-ES-20	INVERTER GOODWE HYBRID 120A 6kW 1-PH	GOODWE AUSTRALIA PTY LTD	GW ES 3.0-6.0kW G2 User Manual
GW6000-SBP-20	INVERTER GOODWE 6 kW AC Coupled 1-P	GOODWE AUSTRALIA PTY LTD	GW SBP 3.0-6.0kW User Manual
GW6000N-EH	INVERTER GOODWE HYBRID (HV) 6KW 1-PH	GOODWE AUSTRALIA PTY LTD	GW EH User Manual
GW8500-MS-30	INVERTER GOODWE 8.5KW 1PH 3MPPT MS-30	GOODWE AUSTRALIA PTY LTD	GW M20 G3 User Manual
SE10000H-AUL00BEU4	INVERTER SOLAREEDGE 10000W GENESIS	SOLAR EDGE TECHNOLOGIES PTY LTD	se inverter-installation-guide
SE10000H-AUSNBX14	INVERTER SOLAREEDGE 10000W ENERGY HUB	SOLAR EDGE TECHNOLOGIES PTY LTD	se-single-phase-energy-hub-prism-technology-installation-guide-aus
SE3000H-AUL00BEU4	INVERTER SOLAREEDGE 3000W GENESIS	SOLAR EDGE TECHNOLOGIES PTY LTD	se inverter-installation-guide
SE5000H-AUL00BEU4	INVERTER SOLAREEDGE 5000W GENESIS	SOLAR EDGE TECHNOLOGIES PTY LTD	se inverter-installation-guide
SE5000H-AUSNBX14	INVERTER SOLAREEDGE 5000W ENERGY HUB	SOLAR EDGE TECHNOLOGIES PTY LTD	se-single-phase-energy-hub-prism-technology-installation-guide-aus
SE6000H-AUL00BEU4	INVERTER SOLAREEDGE 6000W GENESIS	SOLAR EDGE TECHNOLOGIES PTY LTD	se inverter-installation-guide
SE6000H-AUSNBX14	INVERTER SOLAREEDGE 6000W ENERGY HUB	SOLAR EDGE TECHNOLOGIES PTY LTD	se-single-phase-energy-hub-prism-technology-installation-guide-aus
SE8250H-AUL00BEU4	INVERTER SOLAREEDGE 8250W GENESIS	SOLAR EDGE TECHNOLOGIES PTY LTD	se inverter-installation-guide
SE8250H-AUSNBX14	INVERTER SOLAREEDGE 8250W ENERGY HUB	SOLAR EDGE TECHNOLOGIES PTY LTD	se-single-phase-energy-hub-prism-technology-installation-guide-aus

---

# ENGINEERING CERTIFICATION

---



**CIVIL & STRUCTURAL ENGINEERS**  
RESIDENTIAL - INDUSTRIAL - COMMERCIAL - PRODUCT DEVELOPMENT

info@mwengineering.melbourne  
Phone: 1300 MWENG-0 (1300 69364-0)  
www.mwengineering.melbourne  
ABN 37 605 815 585

13 September 2023

Clenergy Australia  
1/10 Duerdin Street  
Clayton, VIC 3168

## CERTIFICATION LETTER

Clenergy PV-ezRack SolarRoof Tin and Tile penetrative Flush interface certification (Elite Rail)  
TC2, 2.5, 3 – Wind Region A, B1, B2, C and D Internal REF: 00689-ELT-1 . Project REF: CL-1171-Y.REV.1.

MW Engineering Melbourne, being Structural Engineers within the meaning of Australian regulations, have calculated the maximum spacings for the PV ez-Rack rail system for the following conditions:

- Wind Loads to AS 1170.2-2021
  - o Wind Terrain Category 2, 2.5 and 3
  - o Wind average recurrence of 200 years
  - o Wind Region A, B1, B2, C and D
- Solar panel length up to 2.4 m
- Solar panel width up to 1.2 m

Attached are the tables showing the spacings according to Wind Region, roof pitch, and building height.

The values shown on these tables will be valid unless an amendment is issued on any of the following codes:

- |                                   |                    |
|-----------------------------------|--------------------|
| - AS/NZS 1170.0- 2002 AMDT 4-2016 | General Principles |
| - AS/NZS 1170.1- 2002 AMDT 4-2016 | Imposed Loadings   |
| - AS/NZS 1170.2- 2021             | Wind Loadings      |
| - AS/NZS 1664.1- 1997 AMDT 1:1999 | Aluminium Code     |

Should you have any queries, do not hesitate to contact us.

Best Regards,

A handwritten signature in blue ink, appearing to read 'Alberto Escobar'.

Alberto Escobar  
Civil/Structural Engineer  
BEng MIEAust NER  
PE 0003615  
RPEQ 18759  
BDC 3134  
BPB (NT) 262228ES  
BSP (TAS) 845530344  
[info@mwengineering.melbourne](mailto:info@mwengineering.melbourne)

September 2023



**CIVIL & STRUCTURAL ENGINEERS**  
RESIDENTIAL - INDUSTRIAL - COMMERCIAL - PRODUCT DEVELOPMENT

info@mwengineering.melbourne  
Phone: 1300 MWENG-0 (1300 69364-0)  
www.mwengineering.melbourne  
ABN 37 605 815 585

13 September 2023

Cleenergy Australia  
1/10 Duerdin Street  
Clayton, VIC 3168

**CERTIFICATION LETTER**

Cleenergy PV-ezRack SolarRoof Penetrative Flush and Tilt interface certification (Elite Rail) – TC 2, 2.5, 3 - Wind Region A, B1, B2 C and D Internal REF: 00606-ELT-1 . Project REF: CL-1168-Y.REV.1.

MW Engineering Melbourne, being Structural Engineers within the meaning of Australian regulations, have calculated the maximum spacings for the PV ez-Rack rail system for the following conditions:

- Wind Loads to AS 1170.2-2021
  - o Wind Terrain Category 2, 2.5 and 3
  - o Wind average recurrence of 200 years
  - o Wind Region A, B1, B2, C and D
- Solar panel length up to 2.4 m
- Solar panel width up to 1.2 m

Attached are the tables showing the spacings according to Wind Region, roof pitch, and building height.

The values shown on these tables will be valid unless an amendment is issued on any of the following codes:

- |                                   |                    |
|-----------------------------------|--------------------|
| - AS/NZS 1170.0- 2002 AMDT 4-2016 | General Principles |
| - AS/NZS 1170.1- 2002 AMDT 4-2016 | Imposed Loadings   |
| - AS/NZS 1170.2- 2021             | Wind Loadings      |
| - AS/NZS 1664.1- 1997 AMDT 1:1999 | Aluminium Code     |

Should you have any queries, do not hesitate to contact us.

Best Regards,

Alberto Escobar  
Civil/Structural Engineer  
BEng MIEAust NER  
PE 0003615  
RPEQ 18759  
BDC 3134  
BPB (NT) 262228E5  
BSP (TAS) 845530344  
[info@mwengineering.melbourne](mailto:info@mwengineering.melbourne)

September 2023



**CIVIL & STRUCTURAL ENGINEERS**  
RESIDENTIAL - INDUSTRIAL - COMMERCIAL - PRODUCT DEVELOPMENT

info@mwengineering.melbourne  
Phone: 1300 MWENG-0 (1300 69364-0)  
www.mwengineering.melbourne  
ABN 37 605 815 585

5 April 2023

Clenergy Australia  
1/10 Duerdin Street  
Clayton, VIC 3168

**CERTIFICATION LETTER**

Clenergy PV-ezRack Solar Roof Certification – TC2, 2.5, 3 – Wind Region A, B1, B2, C, D. Internal REF: 00115. Project REF: CL-088-SM-REV-K.

MW Engineering Melbourne, being Structural Engineers within the meaning of Australian regulations, have calculated the maximum spacings for the PV ez-Rack rail system for the following conditions:

- Wind Loads to AS 1170.2-2021
  - o Wind Terrain Category 2, 2.5 and 3
  - o Wind average recurrence of 200 years
  - o Wind Region A, B1, B2, C, D
- Solar panel length up to 2.4m
- Solar panel width up to 1.2m

Attached are the tables showing the spacings according to Wind Region, roof pitch, and building height.

The values shown on these tables will be valid unless an amendment is issued on any of the following codes:

- |                                   |                    |
|-----------------------------------|--------------------|
| - AS/NZS 1170.0- 2002 AMDT 4-2016 | General Principles |
| - AS/NZS 1170.1- 2002 AMDT 4-2016 | Imposed Loadings   |
| - AS/NZS 1170.2- 2021             | Wind Loadings      |
| - AS/NZS 1664.1- 1997 AMDT 1:1999 | Aluminium Code     |

Should you have any queries, do not hesitate to contact us.

Best Regards,

Alberto Escobar  
Civil/Structural Engineer  
BEng MIEAust NER  
PE 0003615  
RPEQ 18759  
BDC 3134  
BPP (NT) 262228ES  
BSP (TAS) 845530344  
[info@mwengineering.melbourne](mailto:info@mwengineering.melbourne)

April 2023



**CIVIL & STRUCTURAL ENGINEERS**  
RESIDENTIAL - INDUSTRIAL - COMMERCIAL - PRODUCT DEVELOPMENT

info@mwengineering.melbourne  
Phone: 1300 MWENG-0 (1300 69364-0)  
www.mwengineering.melbourne  
ABN 37 605 815 585

5 April 2023

Clenergy Australia  
1/10 Duerdin Street  
Clayton, VIC 3168

**CERTIFICATION LETTER**

Clenergy PV-ezRack Solar Roof Certification – TC2, 2.5, 3 – Wind Region A, B1, B2, C, D. Internal  
REF: 00606. Project REF: CL-343-S-REV-7.

MW Engineering Melbourne, being Structural Engineers within the meaning of Australian regulations, have calculated the maximum spacings for the PV ez-Rack rail system for the following conditions:

- Wind Loads to AS 1170.2-2021
  - o Wind Terrain Category 2, 2.5 and 3
  - o Wind average recurrence of 200 years
  - o Wind Region A, B1, B2, C, D
- Solar panel length up to 2.4m
- Solar panel width up to 1.2m

Attached are the tables showing the spacings according to Wind Region, roof pitch, and building height.

The values shown on these tables will be valid unless an amendment is issued on any of the following codes:

- |                                   |                    |
|-----------------------------------|--------------------|
| - AS/NZS 1170.0- 2002 AMDT 4-2016 | General Principles |
| - AS/NZS 1170.1- 2002 AMDT 4-2016 | Imposed Loadings   |
| - AS/NZS 1170.2- 2021             | Wind Loadings      |
| - AS/NZS 1664.1- 1997 AMDT 1:1999 | Aluminium Code     |

Should you have any queries, do not hesitate to contact us.

Best Regards,

Alberto Escobar  
Civil/Structural Engineer  
BEng MIEAust NER  
PE 0003615  
RPEQ 18759  
BDC 3134  
BPP (NT) 262228ES  
BSP (TAS) 845530344  
[info@mwengineering.melbourne](mailto:info@mwengineering.melbourne)

April 2023

**Clenergy Certificates (Complying with AS/NZS 1170.2:2021)**

[Clenergy PV-ezRack Solar Roof Certification - CL-088-S \(Tin & Tile Interface\)](#)

[Clenergy PV-ezRack Solar Roof Certification - CL-530-S-REV-2 \(Penetrative Tilt Interface\)](#)



**Installation Guides (Complying with AS/NZS 1170.2:2021)**

[Clenergy PV-ezRack Solar Roof - Penetrative Flush Installation](#)

[Clenergy PV-ezRack Solar Roof - Penetrative Tilt Legs](#)



[Clenergy PV-ezRack Solar Roof - Penetrative Flush & Tilt with Elite Rail Installation](#)



**Solahart Industries Pty Ltd** (A.B.N. 45064945848)  
Registered Office  
1 Alan Street (PO Box 7508, Silverwater, 2128)  
Rydalmere New South Wales 2116  
Australia

For SERVICE Telephone - **1800 638 011**  
or your nearest Solahart Dealer  
For Sales Telephone - **1300 769 475**  
or your nearest Solahart Dealer  
**www.solahart.com.au**